

# **HALFEN MT-FBC FLEXIBLE BOLT CONNECTIONS**

## **Technical Product Information**





# **We are one team.** **We are Leviat.**

Leviat is the new name of CRH's construction accessories companies worldwide.

Under the Leviat brand, we are uniting the expertise, skills and resources of HALFEN and its sister companies to create a world leader in fixing, connecting and anchoring technology.

The products you know and trust, including the HALFEN Flexible bolt connections, will remain an integral part of Leviat's comprehensive brand and product portfolio. As Leviat, we can offer you an extended range of specialist products and services, greater technical expertise, a larger and more agile supply chain and better, faster innovation.

By bringing together CRH's construction accessories family as one global organisation, we are better equipped to meet the needs of our customers, and the demands of construction projects, of any scale, anywhere in the world.

**This is an exciting change. Join us on our journey.**

**Read more about Leviat at [Leviat.com](https://www.leviat.com)**



Our product brands include:

**Ancon**<sup>®</sup>

  
**HALFEN**

**PLAKA**



**60**

locations

sales in  
**30+**  
countries

**3000**

people worldwide

Imagine. Model. Make.

[Leviat.com](http://Leviat.com)



© Fotolia

## CONTENTS

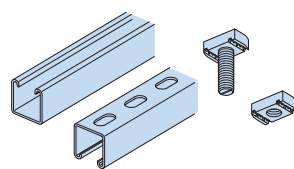
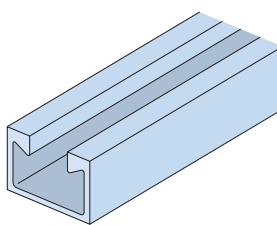
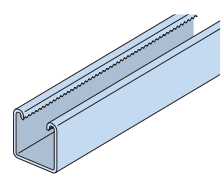
<b>1 HALFEN Industrial Technology</b>	<b>Page 6</b>	
General information	6-7	
<b>2 Framing channels</b>	<b>Page 8</b>	
Introduction – HALFEN Framing channels and HALFEN Bolts	8-9	
Bolt length selection, locking plates, order examples	10	
Framing channels – The advantages at a glance	11	
Materials, finishes, coatings	12-13	
Product range – overview framing channels and bolts	14-15	
<b>3 Framing channels – heavy duty framing system</b>	<b>Page 16</b>	
Profile HM 72/48	16	
HALFEN Bolt HS 72/48	17	
Profiles HM 55/42, HM 52/34	18-19	
Profiles HM 50/30, HM 49/30, HM 50/40, HM 486	20-22	
HALFEN Bolt HS 50/30, HSR 50/30	23	
Locking plates GWP 50/30, GWP 50/40	24	
Profiles HM 40/22, HM 40/25, HM 422	25-26	
HALFEN Bolts and locking plates HS 40/22, HSR 40/22, GWP 40/22	27	
Serrated profile HZM 64/44	28	
Serrated HALFEN Bolt HZS 64/44	29	
Serrated profile HZM 53/34	30	
Serrated HALFEN Bolt HZS 53/34	31	
Serrated profiles HZM 41/27, HZM 38/23	32-33	
HALFEN Bolts HZS 38/23, HS 38/17	34	
Serrated profile HZM 29/20	35	
HALFEN Bolts HZS 29/20, HS 28/15	36	
<b>4 Framing channels – medium duty framing system</b>	<b>Page 37</b>	
Profiles HM 41/41, HL 41/41	37	
Serrated profiles HZM 41/41, HZL 41/41	38	
Profiles HM 41/62, HL 41/62, HM 41/83, HL 41/83	39-40	
Powerclick standard profile HZL 63/63	41	
Profiles HM 41/22, HL 41/22	42	
Serrated profiles HZM 41/22, HZL 41/22	43	
HALFEN Bolts HZS 41/41, HZS 41/22, HS 41/41	44	
Locking plates GWP 41/... and locking plates with spring	45	

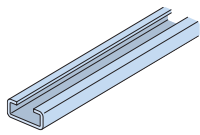
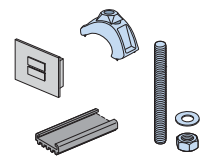
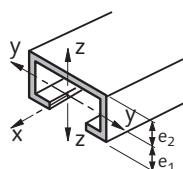
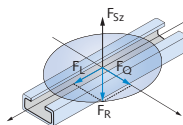

## CONTENTS

<b>5 Framing channels – light duty framing systems</b>	<b>Page 46</b>	
Profiles HM 36/36, HL 36/36, HM 38/17	46	
HALFEN Bolts and locking plates HS 38/17, GWP 38/17	47	
Profiles 28/28, 28/15, HM 315	48–50	
HALFEN Bolts and locking plates 28/15	51	
Profiles and HALFEN Bolts 20/12	52–53	
<b>6 Accessories</b>	<b>Page 54</b>	
Channel end caps, channel covers	55	
HALFEN Bolts – overview	56–57	
Nuts, washers, connection parts	58–59	
Cantilevers – HALFEN Comprehensive adaptable support systems	60	
<b>7 Statics</b>	<b>Page 62</b>	
Cross section properties/bending load capacities: hot-rolled channels	62–63	
Cross section properties/bending load capacities: cold-rolled channels	64–65	
Cross section properties/bending load capacities: slotted channels	66–67	
Point load capacities, welded and dowel fixed framing channels	68–70	
Bending moment of HALFEN Bolts	71	
Flexural buckling – Framing channels as compression elements	72–73	
<b>8 Applications in mechanical engineering</b>	<b>Page 74</b>	
Design references	74	
Selecting the correct bolt length	75	
Channel-bolt connection: pre-tension load	77	
Channel-bolt connection: load capacities/design examples	78–80	
Transfer of dynamic loads	81	
<b>Annex</b>	<b>Page 82</b>	
Tender examples	82	
Powerclick System	83	
Index	84	
Contacts/technical support	87	

## European Regulations

### European Technical Assessment ETA

In 2019, a European Technical Assessment (abbreviated to ETA) for the HALFEN HM Framing channels was granted by the German Institute of Construction Engineering. The ETA was issued based on a technical specification document that includes the relevant assessment procedure. This specification document is defined as a European Assessment Document (abbreviated to EAD).



CPD 0432-CPR-00629  
EAD 330667-00-0602

### What is a CE marking?

The CE marking ensures that the responsibility for the conformity of the product with the performance stated in the declaration of performance (DoP), is assumed by the manufacturer and that all relevant European legislation is complied with.

### European standards

Since its introduction in 2014, the EN 1090 series of standards has become firmly established in the market. The standard covers the design and manufacturing qualifications for steel structures. The European EN 1090-1 standard specifies requirements for proof of conformity for load-bearing steel components placed on the European market as construction products. The proof of conformity includes manufacturing details and if required load-bearing characteristics.

The EN 1090-2 standard specifies requirements for the design of steel structures. This standard applies to structures designed according to the corresponding section of EN 1993 (EC3). Basis of the conformity assessment for steel construction products is the conformity assessment procedure 2+ of the Construction Products Regulation EU No. 305/2011.

Our production is certified by the notified body ZDH ZERT GmbH. The certification not only covers production but also the design services provided by our engineers and their qualifications.



2499 – CPR-0113070-00-05

### Design method

The European standard EN 1993 as well as the ETA were created with the intention to establish uniform, Europe-wide calculation methods for steel structures. However, because these calculation methods have not yet been adopted in all industries, we have decided to provide two tables of load capacities for the cantilever brackets.

- **working loads, referred to as allowable loads “allow F”.**
- **resistance design values, referred to as design values “F<sub>Rd</sub>”.**

The term “design value” is taken from the current applicable standards, for example EN 1993 (EC3) and the European Technical Assessment, with their new safety concepts, and must be strictly differentiated from the term “allowable load”.

The European standard based on the method of “partial safety factors” is applied to material resistance as well as to the action (load).

**The following verification is required:**

$$F_{Ed} \leq F_{Rd}$$

**F<sub>Ed</sub> = calculation value for action**  
**F<sub>Rd</sub> = design value for resistance**

The standard, deterministic safety concept however is based on the method of using a global safety factor for material resistance and is known as the “allowable load method” resp. “allowable tension method”. These methods are used in mechanical and plant engineering. For these cases the allowable values for load capacity are calculated.

**Verification is as follows:**

$$F \leq F_{allow}$$

**F = load on the structure**  
**allow F = allowable load**



## Benefits of HALFEN Framing channels

The versatile HALFEN Framing systems offer a wide range of benefits:

- The versatile HALFEN Channel-bolt system is a supporting as well as a fixing system
- Full flexibility in positioning and dimensioning bolt connections
- Selection of corrosion protection:
  - Strip galvanized framing channels for low demands
  - Hot-dip galvanized framing channels for high demands
  - Framing channels in stainless steel for maximum protection
- Quick assembly and adjustment of plant equipment and structural components
- Modify or update entire projects using only standard tools
- No specialist required to carry out on-site modifications
- Dust free and low noise levels when modification work is done on site
- Corrosion protection is not damaged by bolting
- A large selection of standard channels with excellent load bearing characteristics

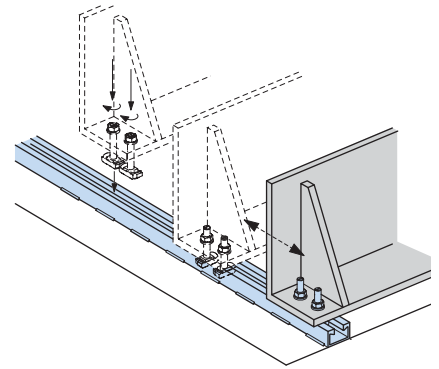

Avoid the following with HALFEN Framing channels:

- Time consuming planning of non-adjustable bolt fixings
- Costly manufacture of bolt fixings
- Costly corrosion protection work when upgrading already completed structural components i.e. when adjusting components "on-site"

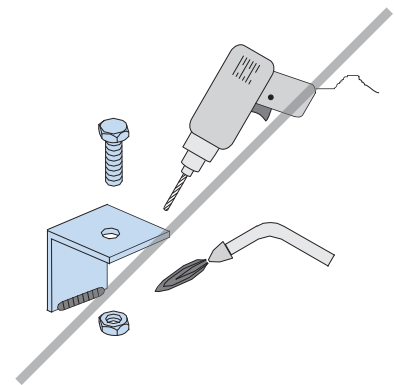

### HALFEN Cast-in channels

All hot-rolled HALFEN Profiles and a number of the light framing channels are also available as **HALFEN HTA/HZA Cast-in channels**. Both versions use the same bolts and locking plates. You can find more information on HALFEN Channels in our Technical Product Information

More information about HALFEN Cast-in channels is available online at



[www.halfen.com//product-ranges/construction/fixing-systems/](http://www.halfen.com//product-ranges/construction/fixing-systems/)

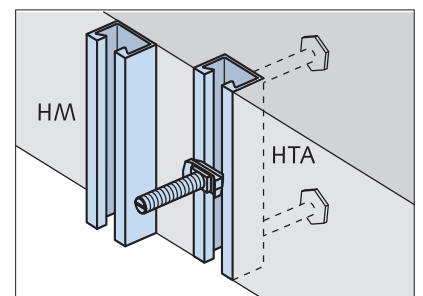

### Quality Management

Quality is the outstanding feature of our products. All materials and products are subjected to the most stringent quality control.

A quality inspection by the DNV GL\* has verified that our quality management system meets the requirements of the ISO 9001:2015 standard.



Certificate no. 202384-2016-AQ-GER-DAkkS

\*merger of DNV (Det Norske Veritas) and GL (Germanischer Lloyd) in 2013

## HALFEN INDUSTRIAL TECHNOLOGY

### Framing channels

Framing channels HM, HL, HZM and HZL

#### Hot-rolled framing channels

The hot-rolling process makes these framing channels ideally suitable for:

- › heavy loads
- › dynamic loads
- › welding

#### Smooth HM Channels



- › very high tension load capacity
- › longitudinal loads are possible when using nibbed bolts (only applies to normal steel)

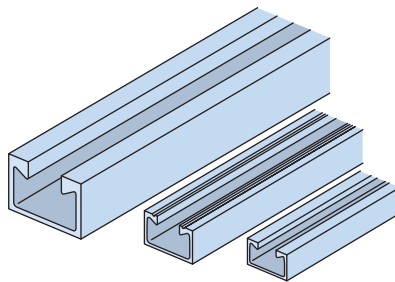

Roller-bearing fixing of a cableway

#### Serrated HZM Channels

- › serration allows high longitudinal loads
- › 5 channel sizes for maximum efficiency

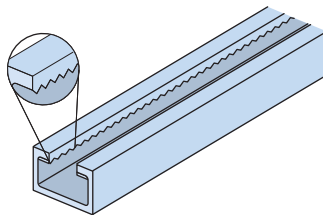

Welding-jig, locomotive construction

#### Cold-rolled framing channels

Cold-rolled channels are economic for lower loads. These channels are available slotted or non-slotted.

#### Smooth HL, HM Channels

- › economical due to large selection of channels

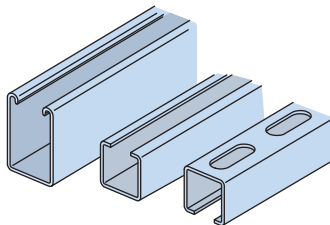

#### Serrated HZL, HZM Channels

- › for loads in longitudinal channel direction
- › positive-locking connection for high channel loads

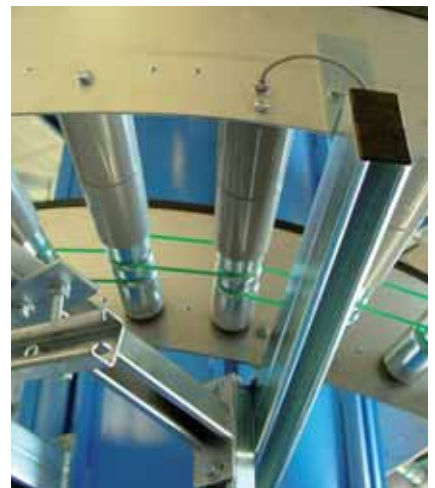
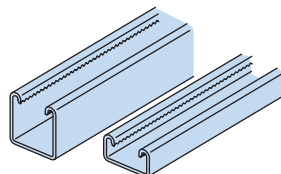

Cantilever fixings in a vertical conveyor system



# HALFEN INDUSTRIAL TECHNOLOGY

## Framing channels

### HALFEN Bolts HS, HZS, HSR

#### Type HS

##### HALFEN Bolts

- > suitable for all channels
- > Load bearing capacity in two directions
- > marked at the bolt end with one notch

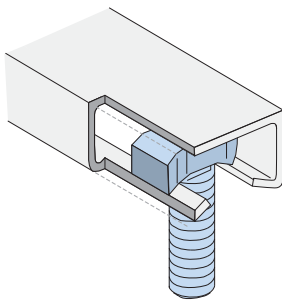

#### Type HSR

##### HALFEN Bolts with nibs

- > suitable for use in hot-rolled, normal steel channels from the heavy duty system
- > nibbed, positive-locked, load bearing in all directions
- > the hammer head design prevents the T-bolts turning under vibration
- > marked at the bolt end with two notches

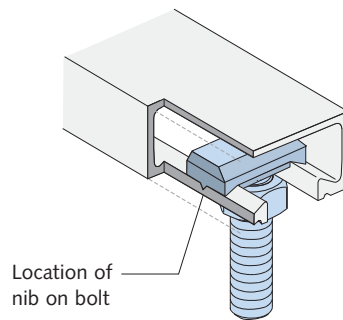

#### Type HZS

##### Serrated HALFEN Bolts

- > for serrated framing channels HZM and HZL
- > serration also provides positive-locked load transmission in longitudinal channel direction; no risk of slippage
- > marked at the bolt end with two notches

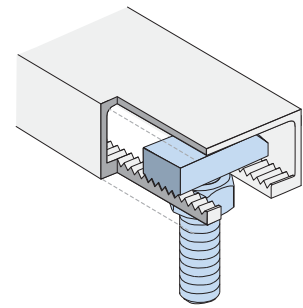

### Identifying HALFEN Bolts

 Bolt identification on the bolt head

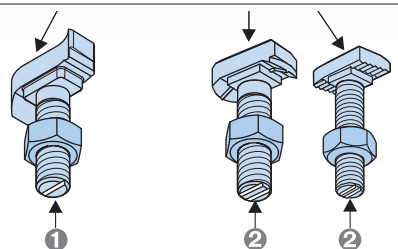

1

2

2

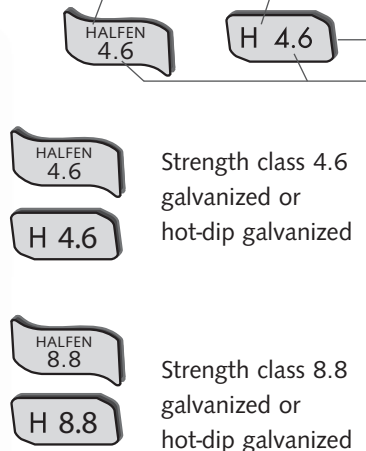

Manufacturer  
(for individual dimension)  
Strength class

Strength class 4.6 galvanized or hot-dip galvanized

Strength class 8.8 galvanized or hot-dip galvanized

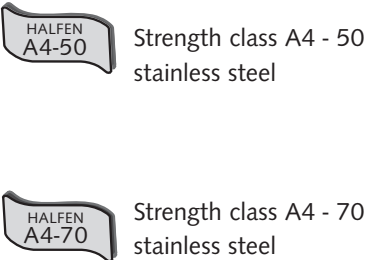

Strength class A4 - 50 stainless steel

Strength class A4 - 70 stainless steel

 Notches at the bolt end

**HS** All Types

**HZS 41/22** 

**HSR** All Types

**HZS 38/23** 

**HZS 29/20** 

Orientation notches: After assembly, check the correct orientation of the notches on the end of the bolts. The notches must be at right angles to the channel length.

## HALFEN INDUSTRIAL TECHNOLOGY

### Framing channels

#### Calculating the bolt length $l_{req}$ for HALFEN Bolts (steel construction)

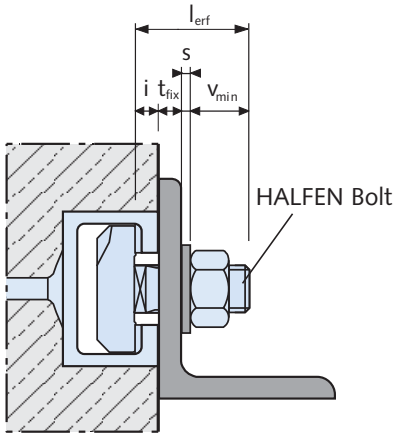

$$l_{req} = t_{fix} + i + s + v_{min}$$

$l_{req}$  = required bolt length  
 $t_{fix}$  = thickness: attached component  
 $i$  = channel lip thickness  
 $s$  = washer thickness → see page 58

$v_{min} = m + u$   
 $m$  = nut height EN ISO 4032  
 $u$  = bolt protrusion approx. 5 mm according to DIN 78 (bolts larger M20 require min. 7 mm)

Dimensions $v_{min}$	
Bolt diameter	$v_{min} = m + u$ [mm]
M6	11.0
M8	12.5
M10	14.5
M12	17.0
M16	20.5
M20	26.0
M24	29.0
M27	31.5
M30	33.5

#### Thickness channel lip $i$

Channel	28/15	29/20	38/17	36/36	38/23	40/22	40/25	41/22	41/27	422	486	49/30	50/30	50/40	52/34	53/34	55/42	64/44	72/48
$i$ [mm]	2.25	5.0	3.0	2.5	5.5	6.0	5.6	7.0	7.0	6.0	6.0	7.39	7.85	7.0	10.5	7.5	12.9	10.0	15.5

#### Locking plates GWP

Locking plates (channel nuts) allow any type of bolt with a metric thread to be used as well as threaded rods.

Locking plates with "grip" (see **medium duty framing system, page 45**). The "serration" grips the channel lips.

Locking plates with spring are used in particular for securing plates or panels (see **medium duty framing system, page 45**).

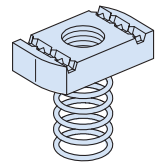
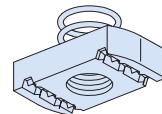
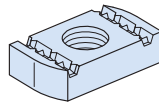
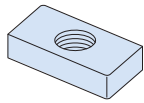
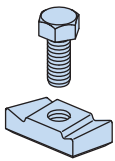

#### Ordering examples

##### Order example – framing channels

HM 50/30 - FV-6070

Type \_\_\_\_\_  
 Material \_\_\_\_\_  
 Length (mm) \_\_\_\_\_

##### Order example – HALFEN Bolts

HS 50/30 M20 × 100 FV 8.8

Type \_\_\_\_\_  
 Thread diam. \_\_\_\_\_  
 Length (mm) \_\_\_\_\_  
 Material \_\_\_\_\_  
 Property class \_\_\_\_\_

or use the 12-digit order no. e.g. 0280.200-00003

or use the 12-digit order no. e.g. 0350.090-00129  
 Order numbers for HALFEN Bolts can be found in the HALFEN pricelist.

# FRAMING CHANNELS

## The advantages at a glance

Whether for low or very high loads: you will always find a cost effective solution for your requirements in the HALFEN product range of framing channels and bolts



Heavy duty framing system

The heavy duty framing channels are mostly hot-rolled and particularly suitable for heavy loads

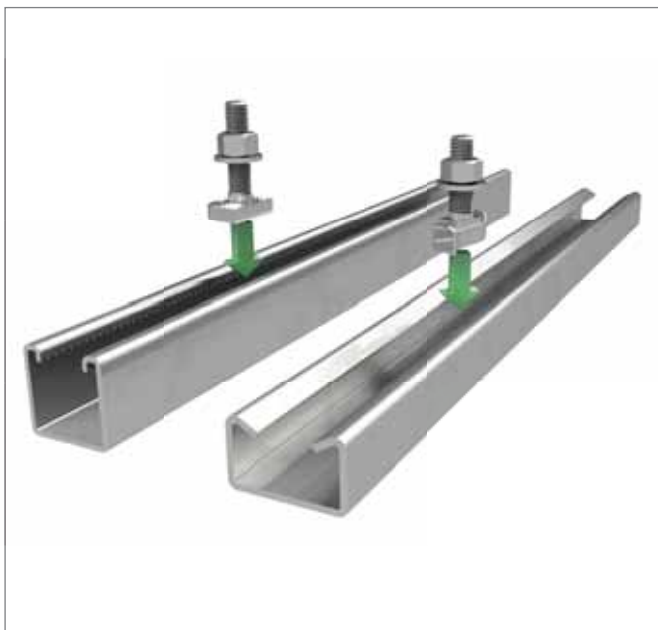

Medium duty framing system

All medium duty framing channels have the same profile width, and are also compatible with the innovative HALFEN Powerclick system.

### Versatile and adaptable

- › adjustable assembly
- › all connected elements remain adjustable. This allows easy replacement or upgrade of components as required
- › almost unlimited in its range of applications; in building projects, industrial projects, steel construction projects, engineering projects, vehicle manufacturing and many other areas

### Safe and reliable

- › corrosion protection is not damaged by bolting
- › large selection of standard channels with optimal load bearing capacities
- › serrated channels for positive-lock connections





Light duty framing system

The light duty framing channel is the perfect fixing solution for low load applications.

# HALFEN INDUSTRIAL TECHNOLOGY

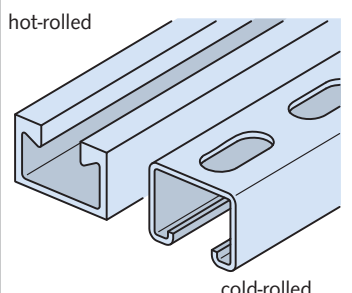
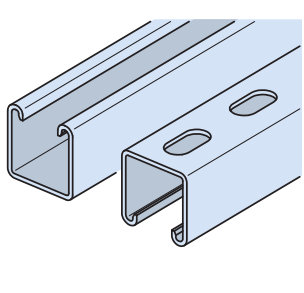
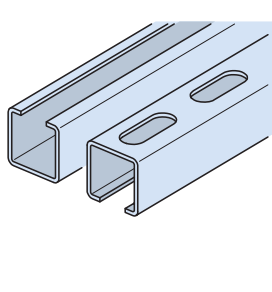
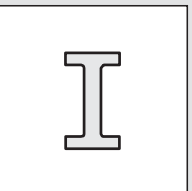
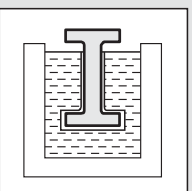
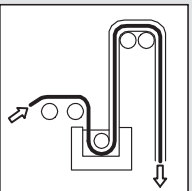
## Materials, Types

HALFEN Channels		Heavy duty framing systems	Medium duty framing systems	Light duty framing systems
		 <p>hot-rolled cold-rolled</p> <p>Pages 16–36</p>	 <p>Pages 37–45</p>	 <p>Pages 46–53</p>
Material: Order code				
 <p>Mill-finished</p>	<p><b>WB</b></p> <p>Hot-rolled material S235JR, acc. to EN 10025, material no. 1.0038</p> <p>Type HZM: S275JR, material no. 1.0044, acc. to EN 10025</p> <p>Cold-rolled: material S235JR, acc. to EN 10025 mill-finished</p>	<p>Material S235JR, acc. to EN 10025, material no. 1.0038</p>	<p>Material S235JR, acc. to EN 10025, material no. 1.0038</p>	
 <p>Hot-dip galvanized acc. to EN ISO 1461 suitable for outdoor application</p>	<p><b>FV</b></p> <p>Hot-rolled material S235JR, acc. to EN 10025, material no. 1.0038</p> <p>type HZM: S275JR acc. to EN 10025</p> <p>Cold-rolled: material S235JR, acc. to EN 10025 Hot-dip galvanized, acc. to EN ISO 1461, zinc coating min. 50 µm</p>	<p>Material S235JR, acc. to EN 10025, material no. 1.0038</p> <p>Hot-dip galvanized, acc. to EN ISO 1461 zinc coating min. 50 µm</p>	<p>Material S235JR, acc. to EN 10025, material no. 1.0038</p> <p>Hot-dip galvanized, acc. to EN ISO 1461, zinc coating min. 50 µm</p>	
 <p>Strip-galvanized acc. to EN 10142 suitable for indoor application</p>	<p><b>SV</b></p>	<p>DX51D + Z275NA, material no. 1.0226, acc. to EN 10346</p> <p>Sendzimir galvanized, hot-dip galvanized min. 20 µm</p>	<p>DX51D + Z275NA, material no. 1.0226, acc. to EN 10346</p> <p>Sendzimir galvanized, hot-dip galvanized min. 20 µm</p>	
 <p>Stainless steel acc. to EN 10088 and EN 1993-1-4</p>	<p><b>A2</b></p>		<p>Material no. 1.4301, acc. to EN 10088</p>	
	<p><b>A4</b></p>	<p>Material no. 1.4571 / 1.4404, acc. to EN 10088</p>	<p>Material no. 1.4571 / 1.4404, acc. to EN 10088</p>	
	<p><b>HCR</b></p>	<p>HCR = high corrosion resistant stainless steel, material no. 1.4529 or 1.4547, acc. to EN 10088, for channels 49/30</p>	<p>HCR = high corrosion resistant stainless steel, material no. 1.4529 or 1.4547, acc. to EN 10088, for channels 28/15 and 38/17</p>	

# HALFEN INDUSTRIAL TECHNOLOGY

## Materials, Types

### HALFEN Bolts/Accessories

① HALFEN Bolts with s-shape head for safer assembly. The head shape guarantees better hold, preventing the bolt turning in the channel, even coping with manufacturing tolerances in the channel widths. HALFEN supplies both types; subject to change.

Material: Order code

HALFEN Bolts	Locking plates	Hexagon bolts	Hexagon nuts
<p>Types <b>HS, HSR, HZS</b></p> <p>① Standard s-shaped head</p> <p>alternative shape of bolt head</p> <p>incl. nut</p> <p>Pages 56 – 57</p>	<p>Type GWP</p>	<p>Type <b>HSK</b></p> <p>EN ISO 4017 DIN 933</p> <p>Page 59</p>	<p>Type <b>MU</b></p> <p>DIN EN ISO 4032 DIN 934</p> <p>Page 58</p>

<p>Hot-dip galvanized acc. to EN ISO 10684, for threaded parts acc. to DIN 267 part 10</p>	<b>FV 4.6</b>	Hot-dip galvanized acc. to EN ISO 10684 strength class 4.6 acc. to EN ISO 898-1			
	<b>FV 8.8</b>	Hot-dip galvanized acc. to EN ISO 10684 strength class 8.8 acc. to EN ISO 898-1			Hot-dip galvanized acc. to EN ISO 10684 strength class 8
<p>Zinc-electroplated acc. to DIN 50961, DIN EN 1403, DIN EN ISO 4042</p> <p>zinc flake coating</p>	<b>*GV 4.6</b>	Zinc-electroplated with special coating Cr(VI)-free, GVs zinc coating min. 12 µm, strength class 4.6 acc. to EN ISO 898-1	Zinc-electroplated Cr(VI)-free, zinc cover min. 5 µm		
	<b>*GV 8.8</b>	Zinc-electroplated with special coating Cr(VI)-free, GVs zinc coating min. 12 µm, strength class 8.8 acc. to EN ISO 898-1		Zinc-electroplated Cr(VI)-free, zinc cover ca. 5 µm, strength class 8.8	Zinc-electroplated Cr(VI)-free, zinc cover min. 5 µm, strength class 8
	<b>zl</b>	Zinc flake coating (only Type HZS 41/41)			

\*HS 40/22 and HS 50/30 bolts in grade GVs4.6 and GVs8.8 will be phased out in 2021 and will be replaced by grade FV4.6 and FV8.8 bolts (other GVs bolts listed in the bolt overview tables remain available).

<p>Stainless steel acc. to EN 10088 or EN 1993-1-4</p>	<b>A2</b>	Strength class 50 acc. to EN ISO 3506-1			Stainless steel A2	
		Strength class 70 acc. to EN ISO 3506-1				
	<b>A4</b>	Strength class 50 acc. to EN ISO 3506-1	Stainless steel A4		Stainless steel A4-70	Stainless steel A4-70 or A4-80
		Strength class 70 acc. to EN ISO 3506-1				
	<b>HCR</b>	Material HCR-50, material no. 1.4529, acc. to EN ISO 3506-1 on request				
	<b>FA</b>	Strength class 70 material no. 1.4462				

# HALFEN INDUSTRIE-TECHNIK

## Product Range Overview: Framing Channels and HALFEN Bolts

Heavy duty framing system						
Hot-rolled				Cold-rolled		
HM 72/48 NEW! CE European Technical Assessment ETA-19/0438 72 33 48,5	HM 55/42 NEW! CE European Technical Assessment ETA-19/0438 54,5 26 42	HM 52/34 NEW! CE European Technical Assessment ETA-19/0438 52,5 22,5 33,5	HM 50/30 NEW! CE European Technical Assessment ETA-19/0438 49 22,5 30	HM 49/30 50 22 30	HM 50/40, HL 50/40 49 22 39	HM 486 48 22 27
HS 72/48, HSR 72/48, GWP 72/48		HS 50/30	HS 50/30, HSR 50/30, GWP 50/30	HS 50/30, GWP 50/30 bzw. GWP 50/40		





Medium duty framing system					
Cold-rolled	Cold-rolled, serrated	Cold-rolled		Cold-rolled, serrated	
HM 41/41, HL 41/41 41 22 41	HZM 41/41, HZL 41/41 41 22 41	HM 41/62, HL 41/62 41 22 62	HM 41/83, HL 41/83 41 22 83	HZL 63/63 63 22 63	HZM 41/22, HZL 41/22 41 22 21
HZS/HS 41/41, HZS 41/22 GWP 41/41, GWP 41/22					

Light duty framing system					
Cold-rolled				Cold-rolled	
HM 36/36, HL 36/36 36 18 36	HM 38/17 38 18 17,5	HM 28/28, HL 28/28 28 12 28	HM 28/15, HL 28/15 28 12 15	HM 315 30 16 15	HM 20/12, HL 20/12 20 10 12
HS 38/17, GWP 38/17		HS 28/15, GWP 28/15		GWP 28/15	HS 20/12, GWP 20/12

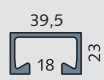

# HALFEN INDUSTRIE TECHNIK

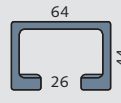
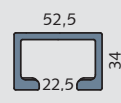
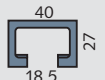
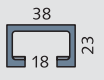
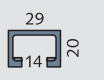
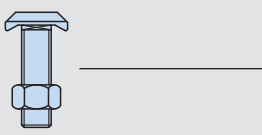
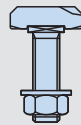
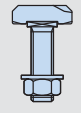
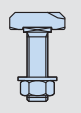
## Product Range Overview: Framing Channels and HALFEN Bolts

Hot-rolled	Cold-rolled		Hot-rolled, serrated				
HM 40/22	HM 40/25	HM 422	HZM 64/44	HZM 53/34	HZM 41/27	HZM 38/23	HZM 29/20
 							
							
HS 40/22, HSR 40/22, GWP 40/22			HZS 64/44	HZS 53/34	HZS 38/23	HZS 38/23, HS 38/17	HZS 29/20, HS 28/15

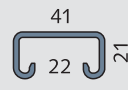
Cold-rolled
HM 41/22, HL 41/22

### Material and finishes:

- Sendzimir galvanized SV
- Hot-dip galvanized FV or mill finish WB
- Stainless steel A2 1.4301/1.4307
- Stainless steel A4 1.4571/1.4404
- Stainless steel HCR 1.4547/1.4529

Further information on materials and finishes → see page 12

 HZM/HZL serrated profiles

### Material grades: abbreviations

- A2:** Steel of corrosion resistance class (CRC) II according to EN 1993-1-4 : 2015-10, table A.3
- A4:** Steel of corrosion resistance class (CRC) III according to EN 1993-1-4 : 2015-10, table A.3
- HCR:** Steel of corrosion resistance class (CRC) V according to EN 1993-1-4 : 2015-10, table A.3

1 FRAMING CHANNELS

2 HEAVY DUTY FRAMING SYSTEMS

3 MEDIUM DUTY FRAMING SYSTEMS

4 LIGHT DUTY FRAMING SYSTEMS

5 ACCESSORIES

6 STATICS

7 MECHANICAL ENGINEERING

# HALFEN INDUSTRIAL TECHNOLOGY

## Framing Channels – Heavy Duty Framing System

### Framing channel HM 72/48

HM 72/48 hot-rolled

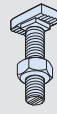
Suitable HALFEN Bolt HS 72/48 and HSR 72/48 → see page 17

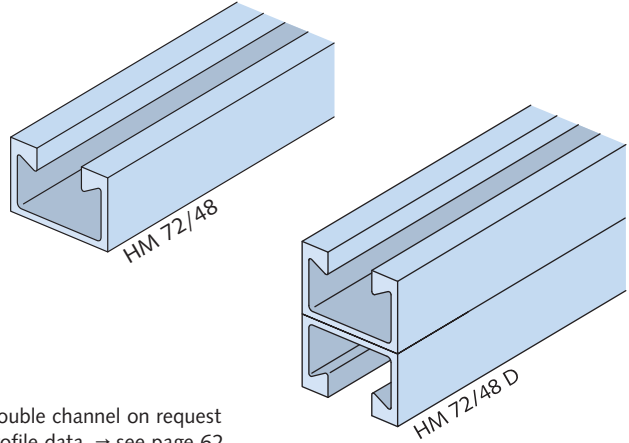
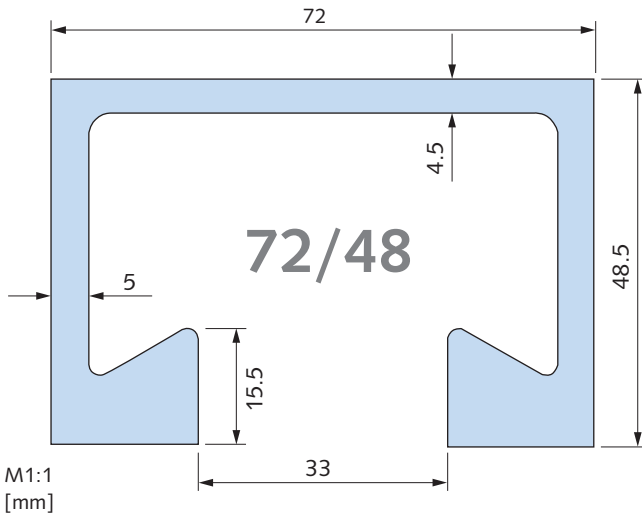

Double channel on request profile data, → see page 62

Dimensions and cross section properties									Load capacities				
Material	Order no.	Length [mm]	Weight G [kg/m]	Cross section area A [cm <sup>2</sup> ]	Moment of inertia		Section modulus		Max. point-load bearing capacity		Bending load capacity at span L		
					$I_y$ [cm <sup>4</sup> ]	$I_z$ [cm <sup>4</sup> ]	$W_y$ [cm <sup>3</sup> ]	$W_z$ [cm <sup>3</sup> ]	$F_z$ ① [kN]	$e_w$ [cm]	F [kN]		
HM 72/48	0280.												
WB	180-00002	6070	8.85	11.27	34.97	83.35	14.28	23.15	$F_{z,Rd}$	30.0	$F_{Rd}$		
FV	180-00003								66.7		31.2	15.6	10.4
A4	180-00001								allow. $F_z$		allow. F		
									47.6		22.3	11.2	7.4

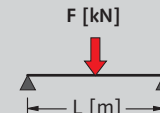
①  $F_z$  = max. load bearing capacity of the channel lips – see also page 68

### Accessories

VUS 72/49 Washer  
→ see page 58

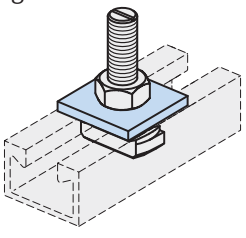

### Further design properties

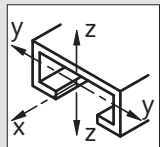

Cross section data  
→ page 62

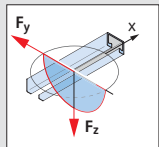

Point-load capacity  
→ pages 62

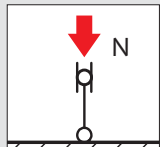

Flexural buckling  
→ page 72

# HALFEN INDUSTRIAL TECHNOLOGY

## Framing Channels – Heavy Duty Framing System

### HALFEN Bolts HS 72/48 and HSR 72/48

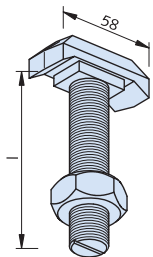

**HS 72/48**  
HALFEN Bolt  
incl. nut

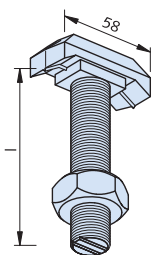

**HSR 72/48**  
HALFEN Bolt with  
nib incl. nut, for  
hot-rolled channels  
in mild steel WB/FV

HS 72/48 available bolts									
Length l [mm]	M20	M24	M27	M30	Length l [mm]	M20	M24	M27	M30
50	FV4.6	FV4.6 A4-50	-	-	100	FV4.6	FV4.6 A4-50	FV8.8	FV4.6
	FV8.8	-	-	-		FV4.6	FV4.6 GVs8.8	-	FV4.6
75	FV4.6	FV4.6	FV4.6	FV4.6	200	FV4.6	FV4.6	-	FV4.6
	GVs8.8	FV 8.8	-	-		FV4.6	FV4.6	-	FV4.6

HSR 72/48 available bolts	
Length l [mm]	M20
75	FV8.8

### Load bearing capacities for HALFEN Bolts ①

Thread $\phi$	Load capacities for HALFEN Bolts				Recommended load capacity per HALFEN Bolt in channel longitudinal direction				Recommended torque				
		F [kN] ①			HSR	F <sub>x</sub> [kN]			HSR v = 3 ③	T <sub>inst</sub> [Nm]			
		HS	HS	A4-50		HS ②	HSR v = 3 ③	HS		HSR			
72/48		4.6	8.8	A4-50	8.8	4.6	8.8	A4-50	8.8	4.6	8.8	A4-50	8.8
M20	F <sub>Rd</sub>	35.2	78.4	-	78.4	1.96	6.58	-	10.5	130	360	-	400
	allow. F	25.1	56.0	-	56.0	1.4	4.7	-	7.5				
M24	F <sub>Rd</sub>	50.7	113.0	44.5	-	2.8	9.52	2.8	-	250	620	200	-
	allow. F	36.2	80.7	31.8	-	2.0	6.8	2.0	-				
M27	F <sub>Rd</sub>	66.0	146.9	-	-	3.64	12.46	-	-	340	900	-	-
	allow. F	47.1	104.9	-	-	2.6	8.9	-	-				
M30	F <sub>Rd</sub>	80.6	-	-	-	4.48	15.26	-	-	460	1200	-	-
	allow. F	57.6	-	-	-	3.2	10.9	-	-				

① Note: do not exceed the max. channel load bearing capacity

② Load capability through friction

③ Acc. to expert report

### Locking plates

#### Locking plate GWP 72/48

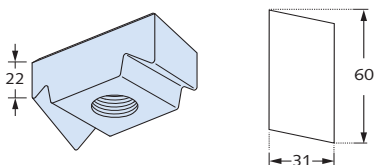

GWP 72/48 available locking plates				
GV thread	A4 thread	a [mm]	b [mm]	d [mm]
M12	M12	60	31	22
M16	M16			
M20	M20			

#### Load capacities GWP 72/48

Thread	Load capacity [kN]	
	F <sub>Rd</sub>	allow. F
M12	F <sub>Rd</sub>	13.0
	allow. F	9.3
M16	F <sub>Rd</sub>	24.2
	allow. F	17.3
M20	F <sub>Rd</sub>	30.8
	allow. F	22.0

# HALFEN INDUSTRIAL TECHNOLOGY

## Framing Channels – Heavy Duty Framing System

### Framing channel HM 55/42

HM 55/42 hot-rolled

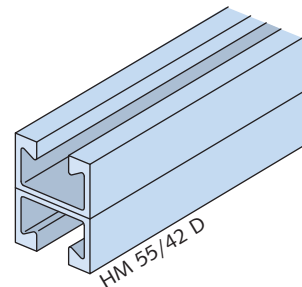
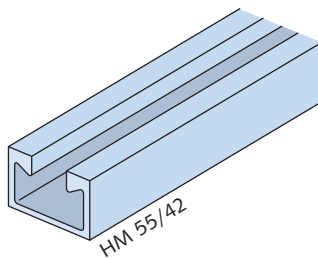
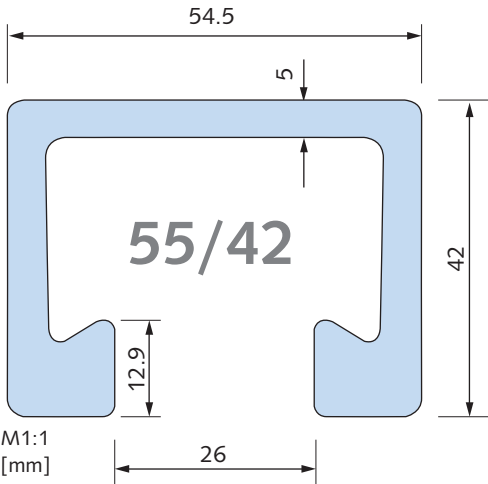
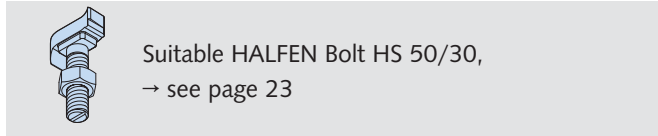

Double channel on request  
profile data, -> see page 62

Dimensions and cross section properties								Load capacities						
Material	Order no.	Length [mm]	Weight G [kg/m]	Cross section area A [cm <sup>2</sup> ]	Moment of inertia I <sub>y</sub> [cm <sup>4</sup> ] I <sub>z</sub> [cm <sup>4</sup> ]		Section modulus W <sub>y</sub> [cm <sup>3</sup> ] W <sub>z</sub> [cm <sup>3</sup> ]		Max. point-load bearing capacity F <sub>z</sub> [kN] e <sub>w</sub> [cm]		Bending load capacity at span L F [kN] L [m]			
HM 55/42	0280.													
WB	290-00001	6070	6.76	8.6	18.75	36.29	8.49	13.32	F <sub>z,Rd</sub>	25.0	F <sub>Rd</sub>			
								55.6			23.5	11.7	7.8	
FV	290-00002								allow. F <sub>z</sub>		allow. F			
									39.7		16.8	8.4	5.6	

① F<sub>z</sub> = max. load bearing capacity of the channel lips – see also page 68

### Accessories

VUS 72/49 Washer  
-> see page 58

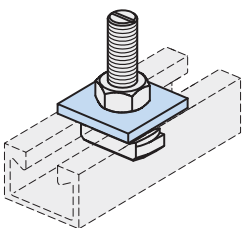

### Further design properties

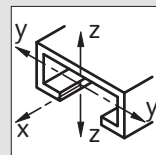

Cross section data  
-> page 62

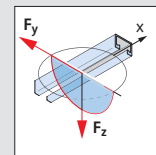

Point-load capacity  
-> pages 68

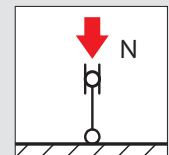

Flexural buckling  
-> page 72

# HALFEN INDUSTRIAL TECHNOLOGY

## Framing Channels – Heavy Duty Framing System

### Framing channel HM 52/34

HM 52/34 hot-rolled



Suitable HALFEN Bolts and locking plates HS 50/30, HSR 50/30, GWP 50/40 and GWP 50/30 → see pages 23–24

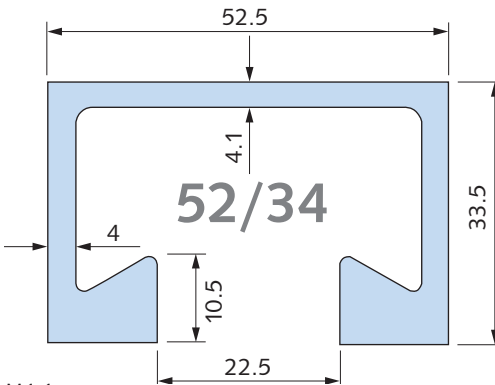

M1:1 [mm]

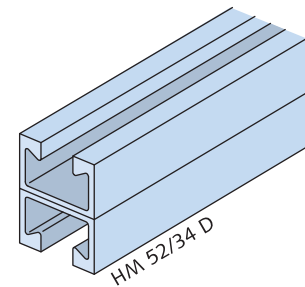
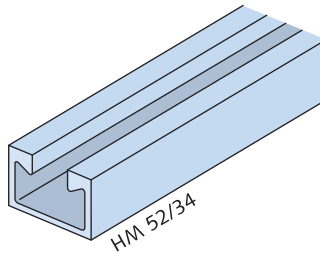

Double channel on request  
profile data → see page 62

Dimensions and cross section properties									Load capacities				
Material	Order no.	Length [mm]	Weight G [kg/m]	Cross section area A [cm <sup>2</sup> ]	Moment of inertia		Section modulus		Max. Point-load bearing capacity		Bending load capacity at span L		
					$I_y$ [cm <sup>4</sup> ]	$I_z$ [cm <sup>4</sup> ]	$W_y$ [cm <sup>3</sup> ]	$W_z$ [cm <sup>3</sup> ]	$F_z$ ① [kN]	$e_w$ [cm]	F [kN]		
HM 52/34	0280.										F [kN]		
WB	190-00002	6070	4.98	6.35	9.33	23.74	5.36	9.04	$F_{z,Rd}$ 37.8	$e_w$ 20.0	$F_{Rd}$		
FV	190-00003										12.3	6.1	3.9
A4	190-00001										allow. F		
									27.0		8.8	4.4	2.8

①  $F_z$  = max. load bearing capacity of the channel lips – see also page 68

### Accessories

VUS 52/34 Washer  
→ see page 58

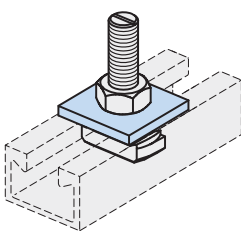

PA - 22 Channel cover  
→ see page 55

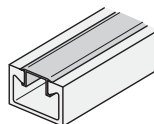

HPE 52/34 Channel end cap  
→ see page 55

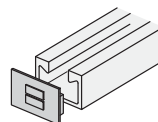

### Further design properties

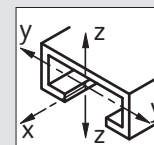

Cross section data  
→ page 62

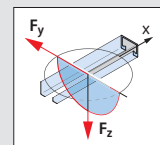

Point load capacity  
→ page 68

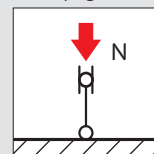

Flexural buckling  
→ page 72

# HALFEN INDUSTRIAL TECHNOLOGY

## Framing Channels – Heavy Duty Framing System

### Framing channel HM 50/30 and HM 49/30

HM 50/30 hot-rolled

HM 49/30 cold-rolled

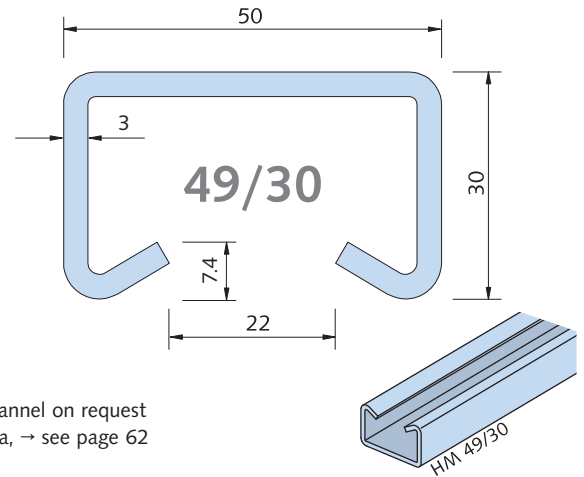
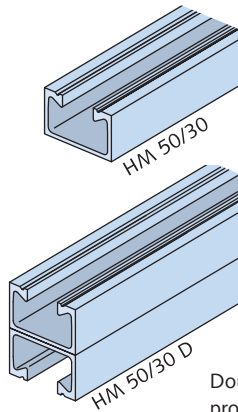
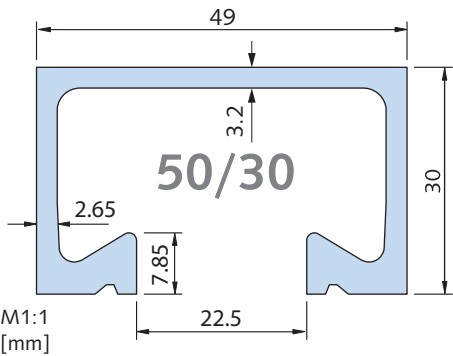

Double channel on request  
profile data, → see page 62

Dimensions and cross section properties									Load capacities						
Material	Order no.	Length [mm]	Weight G [kg/m]	Cross section area A [cm <sup>2</sup> ]	Moment of inertia		Section modulus		Max. point-load bearing capacity		Bending load capacity at span L				
					$I_y$ [cm <sup>4</sup> ]	$I_z$ [cm <sup>4</sup> ]	$W_y$ [cm <sup>3</sup> ]	$W_z$ [cm <sup>3</sup> ]	$F_z$ ① [kN]	$e_w$ [cm]	0.5 m	1.0 m	1.5 m		
HM 50/30	0280.														
WB	200-00002								$F_{z,Rd}$			$F_{Rd}$			
FV	200-00003	6070	3.26	4.15	5.19	13.99	3.24	5.67	21.1	20	7.5	3.7	2.2		
A4	200-00001								allow. $F_z$		allow. F				
									15.1		5.3	2.7	1.6		
HM 49/30	0280.														
WB	220-00001								$F_{z,Rd}$			$F_{Rd}$			
FV	220-00002	6070	2.88	3.67	4.16	13.23	2.35	5.29	6.9	46	6.1	3.0	1.7		
A2 ②	220-00003								allow. $F_z$		allow. F				
A4	220-00004								4.9		4.3	2.2	1.2		

①  $F_z$  = max. load bearing capacity of the channel lips; ② Stainless steel A2 on request. Note: HCR for HM 49/30 on request

### Accessories

VUS 52/34 Washer  
→ see page 58

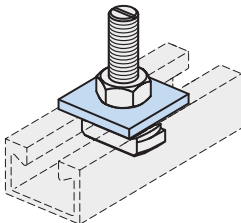

PA - 41 Channel cover  
→ see page 55

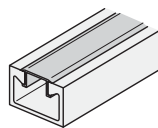

SIC 50/30 Locking washer  
→ see page 58

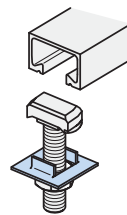

Suitable HALFEN Bolts and locking plates  
HS 50/30, HSR 50/30 and  
GWP 50/30 → see pages 23–24

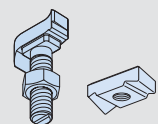

### Further design properties

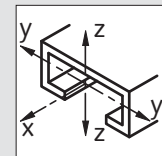

Cross section data →  
→ pages 62, 64

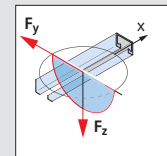

Point-load capacity  
→ pages 68

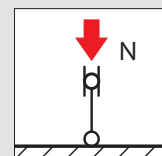

Flexural buckling  
→ pages 72–73



# HALFEN INDUSTRIAL TECHNOLOGY

## Framing Channels – Heavy Duty Framing System

### Framing channel HM and HL 50/40

HM 50/40 and HL 50/40 cold-rolled

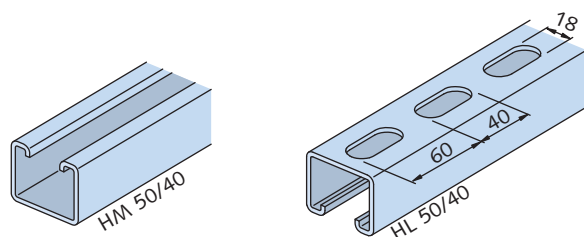
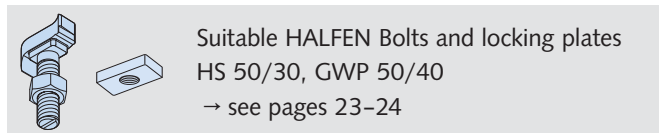
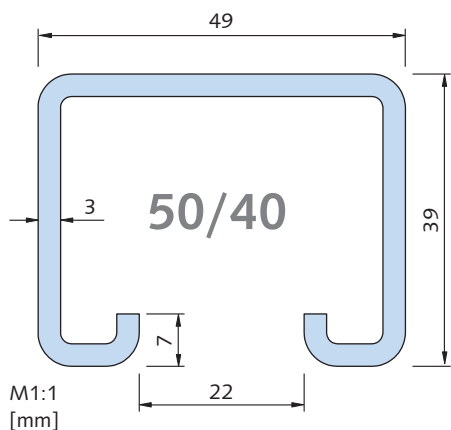

Dimensions and cross section properties									Load capacities				
Material	Order no.	Length [mm]	Weight G [kg/m]	Cross section area A [cm <sup>2</sup> ]	Moment of inertia $I_y$ [cm <sup>4</sup> ]		Section modulus $W_y$ [cm <sup>3</sup> ]		Max. point-load bearing capacity $F_z$ ① [kN]	$\leq e_w$ [cm]	Bending load capacity at span L F [kN]		
											0.5 m	1.0 m	1.5 m
HM 50/40	0280.	6000	3.35	4.26	8.64	15.49	3.96	6.32	$F_{z,Rd}$	63.0	$F_{Rd}$		
WB	090-00002								7.6		9.5	4.7	3.2
FV	090-00003								allow. $F_z$		allow. F		
A4	090-00001								5.4		6.8	3.4	2.3
HL 50/40	0281.	6000	3.15	3.73	7.14	15.36	3.65	6	$F_{z,Rd}$	53.0	$F_{Rd}$		
WB	100-00001								7.6		8.0	4.1	2.7
FV	100-00002								allow. $F_z$		allow. F		
A4	100-00003								5.4		5.7	2.9	1.9

①  $F_z$  = max. load bearing capacity of the channel lips

### Accessories

HPE 50/40 Channel end cap  
→ see page 55

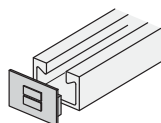

PA - 41 Channel cover  
→ see page 55

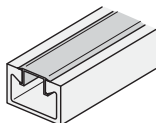

### Further design properties

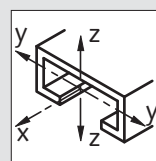

Cross section data  
→ pages 64, 66

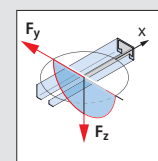

Point-load capacities  
→ page 68

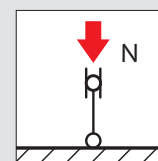

Flexural buckling  
→ page 73

# HALFEN INDUSTRIAL TECHNOLOGY

## Framing Channels – Heavy Duty Framing System

### Framing channel HM 486

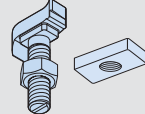

HM 486 cold-rolled

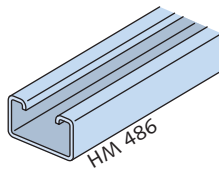
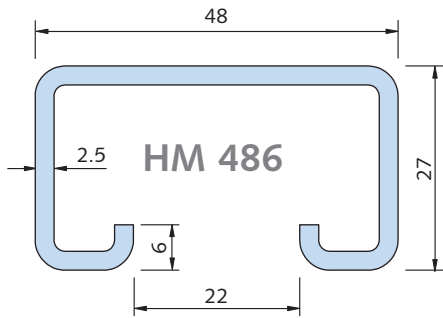

Suitable HALFEN Bolts and locking plates  
HS 50/30 and GWP 50/40  
→ see pages 22–23

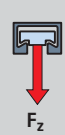

M1:1  
[mm]

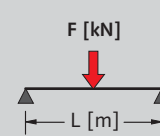
Dimensions and cross section properties									Load capacities					
Material	Order no.	Length [mm]	Weight G [kg/m]	Cross section area A [cm <sup>2</sup> ]	Moment of inertia		Section modulus		Max. point-load bearing capacity	Bending load capacity at span L				
					$I_y$ [cm <sup>4</sup> ]	$I_z$ [cm <sup>4</sup> ]	$W_y$ [cm <sup>3</sup> ]	$W_z$ [cm <sup>3</sup> ]	$F_z$ ① [kN]	$\leq e_w$ [cm]	F [kN]			
HM 486	0280.											0.5 m	1.0 m	1.5 m
WB	100-00001	6000	2.31	2.95	2.97	9.62	1.92	4.01	$F_{Rd,z}$	47.0	$F_{Rd}$			
									4.7		4.6	2.3	1.2	
FV	100-00002								allow. $F_z$		allow. F			
									3.5		3.3	1.7	0.9	

①  $F_z$  = load bearing capacity of the channel lips

### Accessories

### Further design properties

PA - 41 Channel cover  
→ see page 55

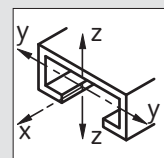
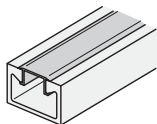

Cross section data  
→ page 64

# HALFEN INDUSTRIAL TECHNOLOGY

## Framing Channels – Heavy Duty Framing System

### HALFEN Bolts HS 50/30 and HSR 50/30

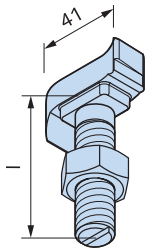

**HS 50/30**  
HALFEN Bolt  
incl. nut

T = partial thread

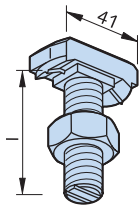

**HSR 50/30**  
HALFEN Bolt with nib,  
incl. nut, for hot-rolled  
profiles in mild steel  
WB/FV

HS 50/30 available bolts									
Length l [mm]	M10	M12	M16	M20	Length l [mm]	M10	M12	M16	M20
30	FV8.8	FV4.6 A4-70	-	-	75	-	-	-	FV4.6 A4-50 FA-70
40	FV8.8	FV4.6 FV8.8 A4-70	FV4.6 FV8.8 A4-50	-	80	-	FV4.6 FV8.8	FV4.6 FV8.8 A4-50 A4-70	FV4.6 FV8.8
45	-	FV8.8	-	FV4.6 FV8.8 A4-50	100	-	FV4.6 FV8.8 A4-50	FV4.6 FV8.8	FV4.6 FV8.8 A4-50 FA-70
50	FV8.8	FV4.6 FV8.8 A4-70	FV4.6 A4-50 A4-70	-	100 T	-	-	A4-50	-
55	-	-	-	FV4.6 A4-50	125	-	FV4.6 FV8.8	-	FV4.6 FV8.8 A4-50
60	-	FV4.6 FV8.8	FV4.6 FV8.8 A4-50	FV8.8	150	-	GVs4.6	FV4.6	FV8.8 A4-50
65	-	-	-	FV4.6 FV8.8	175	-	-	FV8.8	-
70	-	FV8.8	-	-	200	-	GVs4.6	GVs4.6	GVs4.6
					300	-	-	GVs4.6	-



Grade GV4.6 and GV8.8 HS 50/30 bolts will be phased out in 2021 and will be replaced by grade FV 4.6 and FV 8.8 bolts (other GV bolts listed in the bolt overview tables remain available).

High corrosion resistant stainless steel HCR for HS 50/30 on request

HSR 50/30 available bolts									
Length l [mm]	M10	M12	M16	M20	Length l [mm]	M10	M12	M16	M20
40	-	-	FV8.8	-	75	-	-	-	GVs8.8
45	-	-	-	GVs8.8	80	-	-	FV8.8	-
60	-	-	FV8.8	GVs8.8	100	-	-	FV8.8	-

### Load bearing capacities for HALFEN Bolts ①

Thread $\varnothing$	Load capacities for HALFEN Bolts						Recommended load capacity per HALFEN Bolt in channel longitudinal direction					Recommended torque					
	F [kN]						F <sub>x</sub> [kN]					T <sub>inst</sub> [Nm]					
50/30	HS					HSR	HS ②				HSR ③	HS				HSR	
	4.6	8.8	A4-50	A4-70	FA-70	8.8	4.6	8.8	A4-50; A4-70	FA-70	8.8	4.6	8.8	A4-50	A4-70	FA-70	8.8
M10	F <sub>Rd</sub>	8.3	17.2 (18.6)	-	-	-	0.42	1.54	-	-	-	15	40	-	-	-	-
	allow. F	5.9	12.2 (13.3)	-	-	-	0.3	1.1	-	-	-						
M12	F <sub>Rd</sub>	12.1	27.0	10.6	22.7	-	0.7	2.24	0.7	-	-	25	70	25	-	-	-
	allow. F	8.6	19.3	7.6	16.2	-	0.5	1.6	0.5	-	-						
M16	F <sub>Rd</sub>	22.6	50.2	19.8	42.2	-	1.26	4.2	1.26	-	7.0	65	180	60	130	-	200
	allow. F	16.1	35.9	14.1	30.2	-	0.9	3.0	0.9	-	5.0						
M20	F <sub>Rd</sub>	35.2	78.4	30.9	-	66.0	78.4	1.96	1.96	1.96	10.5	130	360	120	-	250	400
	allow. F	25.1	56.0	22.1	-	47.1	56.0	1.4	1.4	1.4	7.5						
M24	F <sub>Rd</sub>	50.7	-	-	-	-	2.8	9.5	-	-	-	230	-	-	-	-	-
	allow. F	36.2	-	-	-	-	2.0	6.8	-	-	-						

① Observe the channel load bearing capacity!

② Load capability through friction

③ acc. to expert report,  $\nu = 3$

( ) only applies to GVs

# HALFEN INDUSTRIAL TECHNOLOGY

## Framing Channels – Heavy Duty Framing System

### Locking plates GWP 50/30

Locking plate  
GWP 50/30

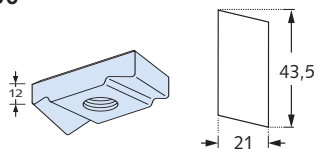

GWP 50/30 available bolts		
FV	GV	A4
-	M8	M8
M10	M10	M10
M12	M12	M12
M16	M16	M16

Load capacities for locking plates 50/30

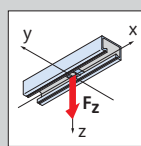

50/30

Thread	Load capacity [kN]	
	$F_{Rd}$	allow. F
M8	$F_{Rd}$	5.6
	allow. F	4.0
M10	$F_{Rd}$	9.0
	allow. F	6.4
M12	$F_{Rd}$	13.0
	allow. F	9.3
M16	$F_{Rd}$	13.0
	allow. F	9.3

### Locking plates GWP 50/40

Locking plate  
GWP 50/40

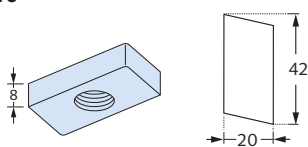

GWP 50/40 available bolts	
GV	A4
M6	M6
M8	M8
M10	M10
M12	M12
M16	M16

Load capacities for locking plates 50/40

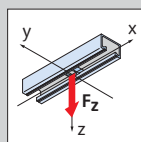

50/40

Thread	Load capacity [kN]	
	$F_{Rd}$	allow. F
M6	$F_{Rd}$	3.1
	allow. F	2.2
M8	$F_{Rd}$	5.6
	allow. F	4.0
M10	$F_{Rd}$	9.0
	allow. F	6.4
M12	$F_{Rd}$	9.0
	allow. F	6.4
M16	$F_{Rd}$	9.0
	allow. F	6.4

# HALFEN INDUSTRIAL TECHNOLOGY

## Framing Channels – Heavy Duty Framing System

### Framing channel HM 40/22, HM 40/25

#### HM 40/22 hot-rolled

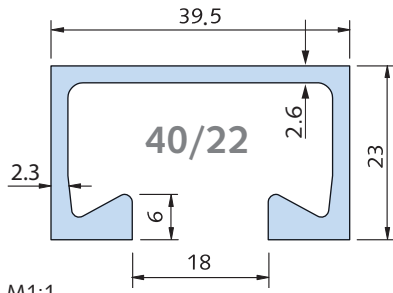

M1:1  
[mm]

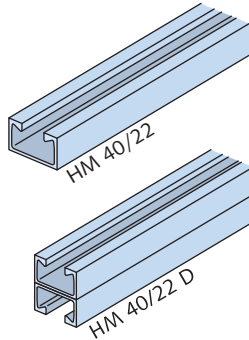

Double channel on request -  
profile data, → see page 62

#### HM 40/25 cold-rolled

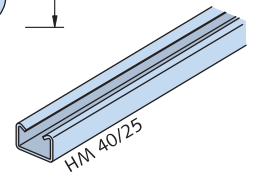
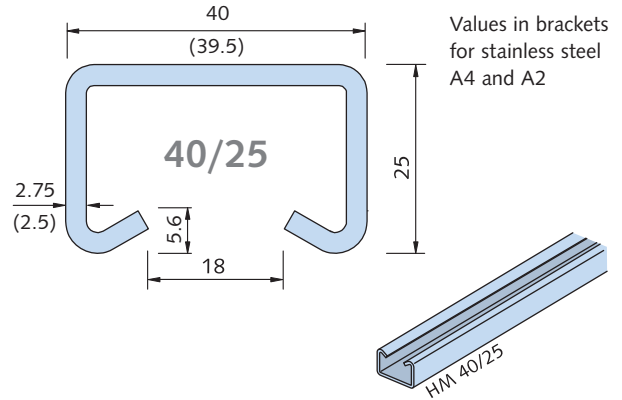

Dimensions and cross section properties									Load capacities				
Material	Order no.	Length	Weight	Cross section area	Moment of inertia		Section modulus		Max. point-load bearing capacity		Bending load capacity at span L		
		[mm]	G [kg/m]	A [cm <sup>2</sup> ]	I <sub>y</sub> [cm <sup>4</sup> ]	I <sub>z</sub> [cm <sup>4</sup> ]	W <sub>y</sub> [cm <sup>3</sup> ]	W <sub>z</sub> [cm <sup>3</sup> ]	F <sub>z</sub> ① [kN]	e <sub>w</sub> [cm]	F [kN]		
											L [m]		
											0.5 m	1.0 m	1.5 m
HM 40/22	0280.	6070	2.12	2.70	1.98	5.77	1.59	2.92	F <sub>z,Rd</sub>	15.0	F <sub>Rd</sub>		
WB	210-00002								14.4		3.7	1.9	0.8
FV	210-00003								allow. F <sub>z</sub>		allow. F		
A4	210-00001								10.3		2.6	1.3	0.6
HM 40/25	0280.	6070	2.09	2.66	2.05	6.09	1.39	3.05	F <sub>z,Rd</sub>	33.0	F <sub>Rd</sub>		
WB	230-00001								5.3		3.6	1.8	0.9
FV	230-00002								allow. F <sub>z</sub>		allow. F		
A2	230-00003								3.8		2.6	1.3	0.6
A4	230-00004												

① F<sub>z</sub> = max. load bearing capacity for the channel lips – see also page 68

#### Accessories

##### VUS 40/25

Washer  
→ see page 58

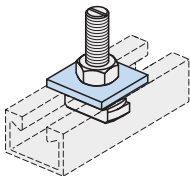

##### SIC 40/22

Locking washer  
→ see page 58

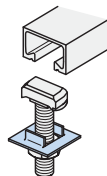

##### SDM - 36/6

Rubber vibration absorber  
→ see catalogue MT-FFC

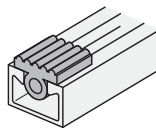

Suitable HALFEN Bolts and locking plates  
HS 40/22, HSR 40/22 and  
GWP 40/22 → see page 27

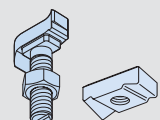

#### Further design properties

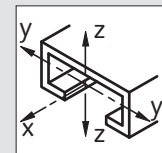

Cross section data  
→ pages 62, 64

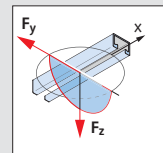

Point-load capacities  
→ pages 68

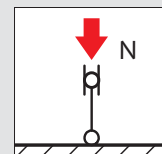

Flexural buckling  
→ pages 72-73

# HALFEN INDUSTRIAL TECHNOLOGY

## Framing Channels – Heavy Duty Framing System

### Framing channel HM 422

HM 422 (C40) cold-rolled

Suitable HALFEN Bolts and locking plates  
HS 40/22 and GWP 40/22  
→ see page 27

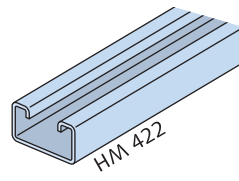
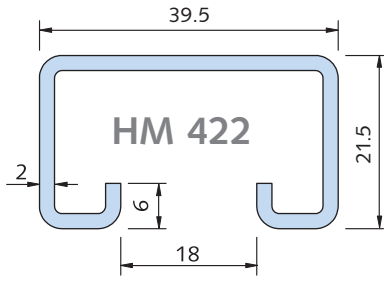

M1:1  
[mm]

Dimensions and cross section properties									Load capacities				
Material	Order no.	Length	Weight	Cross section area	Moment of inertia		Section modulus		Max. point-load bearing capacity		Bending load capacity at span L		
		[mm]	G [kg/m]		$I_y$ [cm <sup>4</sup> ]	$I_z$ [cm <sup>4</sup> ]	$W_y$ [cm <sup>3</sup> ]	$W_z$ [cm <sup>3</sup> ]	$F_z$ [kN]	$e_w$ [cm]	F [kN]		
HM 422	0280.												
WB	110-00001	6000	1.55	1.98	1.27	4.29	1.04	2.17	$F_z$ ①	≤ $e_w$	$F_{Rd}$		
									0.5 m		1.0 m	1.5 m	
									2.5		1.2	0.5	
FV	110-00002								allow. $F_z$		allow. F		
									2.5		1.8	0.9	0.4

①  $F_z$  = max. load bearing capacity of the channel lips

### Accessories

### Further design properties

VUS 40/25

Washer  
→ see page 58

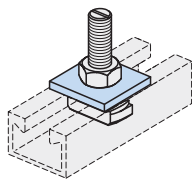

SIC 40/22

Locking washer  
→ see page 58

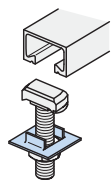

SDM - 36/6

Rubber vibration absorber  
→ see catalogue MT-FFC

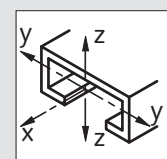
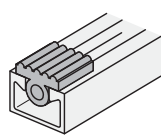

Cross section data  
→ page 64



# HALFEN INDUSTRIAL TECHNOLOGY

## Framing Channels – Heavy Duty Framing System

### HALFEN Bolts HS 40/22 and HSR 40/22

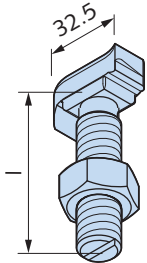

**HS 40/22**  
HALFEN Bolt  
incl. nut

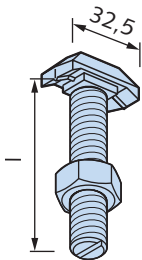

**HSR 40/22**  
HALFEN Bolt with nib,  
incl. nut, for hot-rolled  
profiles in mild steel  
WB/FV

HS 40/22 available bolts							
Length l [mm]	M10	M12	M16	Length l [mm]	M10	M12	M16
20	FV4.6	-	-	60	FV4.6	FV4.6	FV4.6
30	FV4.6	FV4.6	A4-50		FV8.8	FV8.8	FV8.8
	FV8.8	FV8.8		A4-70	A4-50	A4-50	
40	FV4.6	FV4.6	FV4.6	80	FV4.6	FV4.6	FV4.6
	FV8.8	FV8.8	FV8.8		FV8.8	FV8.8	FV8.8
45	-	FV8.8	-	100	FV4.6	FV4.6	FV4.6
	FV4.6	FV4.6	FV4.6		FV8.8	FV8.8	FV8.8
50	-	FV8.8	-	125	FV4.6	FV4.6	FV4.6
	FV4.6	FV4.6	FV4.6		FV8.8	FV8.8	FV8.8
50	-	FV8.8	-	150	-	GVs4.6	FV4.6
	FV4.6	FV4.6	FV4.6		GVs4.6	GVs4.6	GVs4.6
50	-	FV8.8	-	200	-	GVs4.6	GVs4.6
	FV4.6	FV4.6	FV4.6		GVs4.6	GVs4.6	GVs4.6
50	-	FV8.8	-	250	-	-	GVs4.6
	FV4.6	FV4.6	FV4.6		GVs4.6	GVs4.6	GVs4.6
50	-	FV8.8	-	300	-	-	GVs4.6
	FV4.6	FV4.6	FV4.6		GVs4.6	GVs4.6	GVs4.6

**!** Grade GV4.6 and GV8.8 HS 40/22 bolts will be phased out in 2021 and will be replaced by grade FV4.6 and FV8.8 bolts (other GV bolts listed in the bolt overview tables remain available).

HSR 40/22 available bolts			
Length l [mm]	M10	M12	M16
40	-	-	GVs8.8
60	-	-	FV8.8

### Load bearing capacities for HALFEN Bolts ①

Thread $\phi$	Load capacities for HALFEN Bolts						Recommended load capacity per HALFEN Bolt in channel longitudinal direction ②					Recommended torque				
		HS				HSR	HS				HSR ③	HS				HSR
		4.6	8.8	A4-50	A4-70	8.8	4.6	8.8	A4-50	A4-70	8.8	4.6	8.8	A4-50	A4-70	8.8
40/22	$F_{Rd}$	8.3	17.2 (18.6)	-	15.6	-	-	-	0.42	-	15	-	-	30	-	
	allow. F	5.9	12.2 (13.3)	-	11.2	-	0.3	-	0.3	-	25	70	25	-	70	
M10	$F_{Rd}$	12.1	27.0	10.6	-	-	-	0.7	-	-	65	180	60	130	200	
	allow. F	8.6	19.3	7.6	-	-	0.5	1.6	0.5	-	5.0	15	70	25	70	
M12	$F_{Rd}$	22.6	50.2	19.8	42.2	50.2	-	-	1.26	1.26	7.0	65	180	60	130	200
	allow. F	16.1	35.9	14.1	30.2	39.9	0.9	3.0	0.9	0.9	5.0	15	70	25	70	

① Note: do not exceed the channel load bearing capacity    ② Load capability through friction    ③ acc. to expert report,  $v = 3$     ( ) only applies to GVs

### Locking plates GWP 40/22

Locking plate  
GWP 40/22

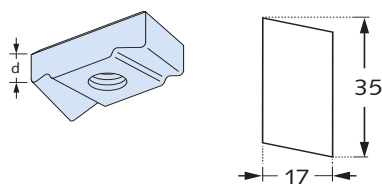

GWP 40/22 available plates				
GV	A4	a [mm]	b [mm]	d [mm]
M5	-	35	17	10
M6	-			
M8	M8	35	17	10
M10	M10			
M12	M12			

### Load capacities for GWP 40/22

40/22	Thread	Load capacity [kN]	
		$F_{Rd}$	allow. F
M5		3.1	2.2
		3.1	2.2
M6		5.6	4.0
		9.0	6.4
M8		13.0	9.3
		13.0	9.3

# HALFEN INDUSTRIAL TECHNOLOGY

## Framing Channels – Heavy Duty Framing System

### Framing channel HZM 64/44

HZM 64/44 hot-rolled, serrated 

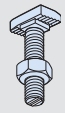

Suitable HALFEN Bolts  
HZS 64/44 → see page 29

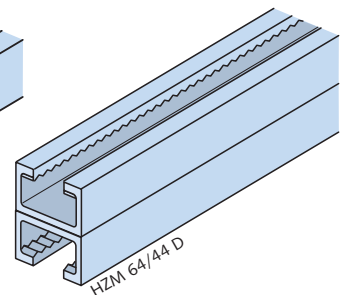
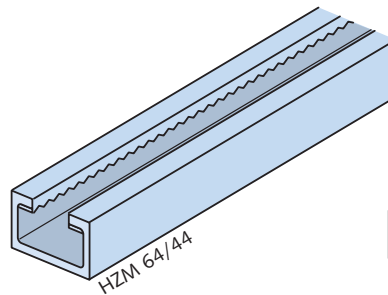
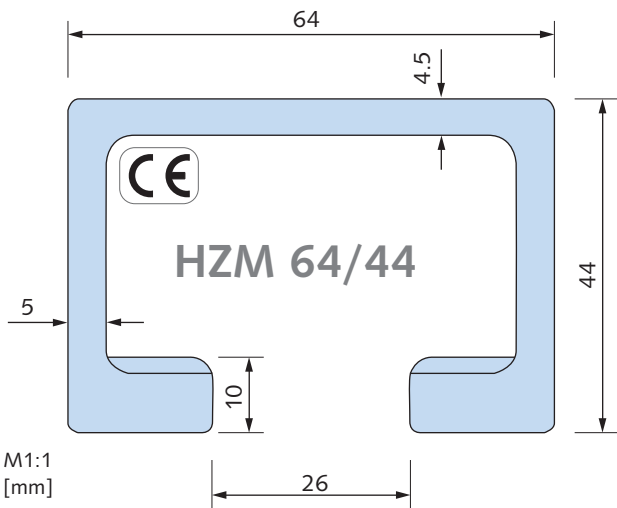

Double channel on request  
profile data, → see page 62

Dimensions and cross section properties									Load capacities				
Material	Order no.	Length	Weight	Cross section area	Moment of inertia		Section modulus		Max. point-load bearing capacity		Bending load capacity at span L		
		[mm]	[kg/m]	[cm <sup>2</sup> ]	$I_y$	$I_z$	$W_y$	$W_z$	$F_z$ ①	$\leq e_w$	F [kN]		
					[cm <sup>4</sup> ]	[cm <sup>4</sup> ]	[cm <sup>3</sup> ]	[cm <sup>3</sup> ]	[kN]	[cm]	L [m]		
HZM 64/44	0284.										0.5 m	1.0 m	1.5 m
WB	080-00002	6070	7.15	9.1	23.83	53.94	10.36	16.85	$F_{z,Rd}$	25.0	$F_{Rd}$		
FV	080-00003								53.3		34.8	17.4	10.0
A4	080-00001								allow. $F_z$		allow. F		
									38.1		24.8	12.4	7.1

①  $F_z$  = max. load bearing capacity of the channel lips – see also page 69

### Accessories

VUS 72/48  
Washer  
→ see page 58

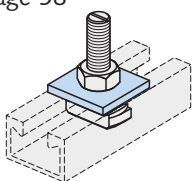

### Further design properties

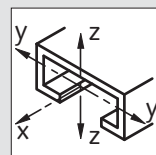

Cross section data  
→ page 62

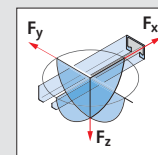

Point-load capacities  
→ pages 69

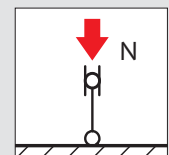

Flexural buckling  
→ page 72

# HALFEN INDUSTRIAL TECHNOLOGY

## Framing Channels – Heavy Duty Framing System

### HALFEN Bolts HZS 64/44

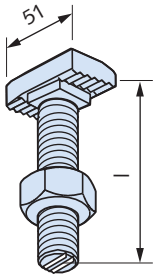

**HZS 64/44**  
HALFEN Bolt,  
serrated  
incl. nut

HZS 64/44 available bolts		
Length l [mm]	M20	M24
80	FV8.8 A4-70	GVs8.8 A4-70 ①
125	GVs8.8 A4-70	-
150	-	GVs8.8 A4-70

① On request

### Load bearing capacities for HALFEN Bolts ①

Thread $\varnothing$	Load capacities for HALFEN Bolts		Max. load capacity per HALFEN Bolt in channel longitudinal direction		Recommended torque		
	 F [kN] ①		 F <sub>x</sub> [kN] ①		 T <sub>inst</sub> [Nm]		
64/44	HZS		HZS		HZS		
		8.8	A4-70	8.8	A4-70	8.8	A4-70
M20	F <sub>Rd</sub>	79.0	51.5	37.8	37.8	350	350
	allow. F	56.4	36.8	27.0	27.0		
M24	F <sub>Rd</sub>	113.7	54.3	37.8	37.8	450	450
	allow. F	81.2	38.8	27.0	27.0		

① Note: do not exceed the max. channel load bearing capacity

In case of simultaneous loading in all directions (longitudinal -x, transverse -y, central tension -z) the resultant load must not exceed the load bearing capacity given in the table.

$$\sqrt{F_x^2 + F_y^2 + F_z^2} \leq \text{allow. F}$$

resp.

$$\sqrt{F_{x,Ed}^2 + F_{y,Ed}^2 + F_{z,Ed}^2} \leq F_{Rd}$$

F<sub>x</sub>, F<sub>y</sub>, F<sub>z</sub> = existing loads  
allow. F = allowable load bearing capacity of the bolt

resp.

F<sub>x,Ed</sub>, F<sub>y,Ed</sub>, F<sub>z,Ed</sub> = design values of action

F<sub>Rd</sub> = design value of resistance

# HALFEN INDUSTRIAL TECHNOLOGY

## Framing Channels – Heavy Duty Framing System

### Framing channel HZM 53/34

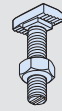

HZM 53/34 hot-rolled, serrated 

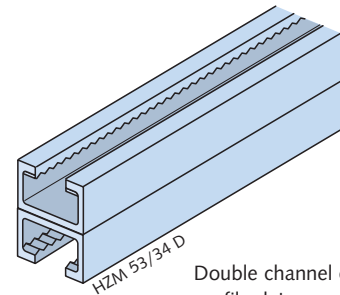
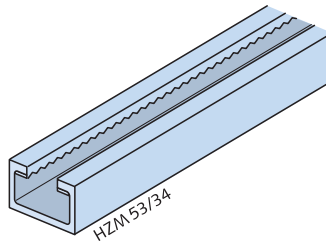
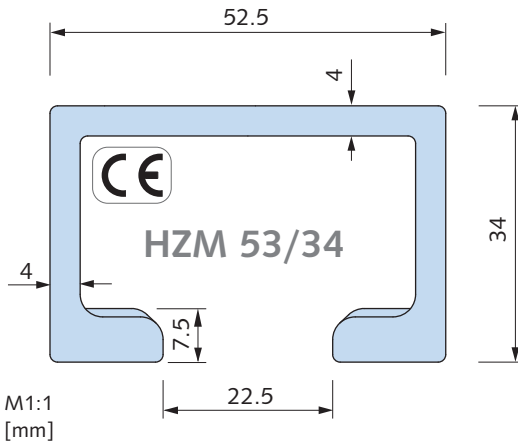

Suitable HALFEN Bolts HZS 53/34  
→ see page 31

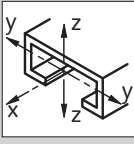

Double channel on request  
profile data, → see page 62

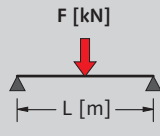
Dimensions and cross section properties									Load capacities				
Material	Order no.	Length [mm]	Weight G [kg/m]	Cross section area A [cm <sup>2</sup> ]	Moment of inertia 		Section modulus W <sub>y</sub> [cm <sup>3</sup> ]		Max. point-load bearing capacity 		Bending load capacity at span L 		
HZM 53/34	0284.				I <sub>y</sub> [cm <sup>4</sup> ]	I <sub>z</sub> [cm <sup>4</sup> ]	W <sub>y</sub> [cm <sup>3</sup> ]	W <sub>z</sub> [cm <sup>3</sup> ]	F <sub>z</sub> ① [kN]	≤ e <sub>w</sub> [cm]	0.5 m	1.0 m	1.5 m
WB	070-00002	6070	4.63	5.88	9.19	23.18	4.95	8.83	F <sub>z,Rd</sub>	20.0	F <sub>Rd</sub>		
FV	070-00003								43.3		17.3	8.6	3.8
A4	070-00001								allow. F <sub>z</sub>		allow. F		
									30.9		12.4	6.2	2.7

① F<sub>z</sub> = max. load bearing capacity of the channel lips – see also page 69

### Accessories

**VUS 52/34**  
Washer  
→ see page 58

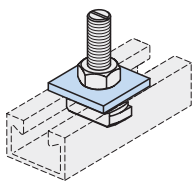

**PA - 22**  
Channel cover  
→ see page 55

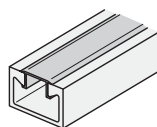

### Further design properties

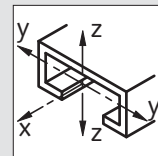

Cross section data  
→ page 62

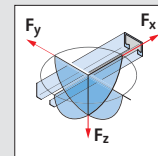

Point-load capacities  
→ pages 69

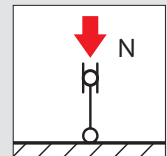

Flexural buckling  
→ page 72

# HALFEN INDUSTRIAL TECHNOLOGY

## Framing Channels – Heavy Duty Framing System

### HALFEN Bolts HZS 53/34

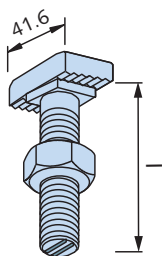

**HZS 53/34**  
HALFEN Bolt,  
serrated  
incl. nut

HZS 53/34 available bolts		
Length l [mm]	M16	M20
60	FV8.8 A4-70	-
65	-	FV8.8 A4-70
100	FV8.8 A4-70	GVs8.8 A4-70

### Load bearing capacities for HALFEN Bolts ①

Thread Ø	Load capacities for HALFEN Bolts		Max. load capacity per bolt in channel longitudinal direction		Recommended torque		
	F [kN] ①		F <sub>x</sub> [kN] ①		T <sub>inst</sub> [Nm]		
53/34	HZS		HZS		HZS		
		8.8	A4-70	8.8	A4-70	8.8	A4-70
M16	F <sub>Rd</sub>	50.5	33.0	30.8	26.6	200	200
	allow. F	36.1	23.6	22.0	19.0		
M20	F <sub>Rd</sub>	79.0	51.5	30.8	26.6	350	350
	allow. F	56.4	36.8	22.0	19.0		

① Note: do not exceed the max. channel load bearing capacity

In case of simultaneous loading in all directions (longitudinal -x, transverse -y, central tension -z) the resultant load must not exceed the load bearing capacity given in the table.



$$\sqrt{F_x^2 + F_y^2 + F_z^2} \leq \text{allow. F}$$

resp.

$$\sqrt{F_{x,Ed}^2 + F_{y,Ed}^2 + F_{z,Ed}^2} \leq F_{Rd}$$

F<sub>x</sub>, F<sub>y</sub>, F<sub>z</sub> = existing loads  
allow. F = allowable load bearing capacity of the bolt

resp.

F<sub>x,Ed</sub>, F<sub>y,Ed</sub>, F<sub>z,Ed</sub> = design values of action

F<sub>Rd</sub> = design value of resistance

# HALFEN INDUSTRIAL TECHNOLOGY

## Framing Channels – Heavy Duty Framing System

### Framing channel HZM 41/27

HZM 41/27 hot-rolled, serrated 

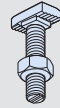

Suitable HALFEN Bolts HZS 38/23  
→ see page 34

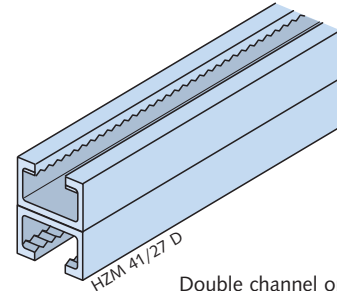
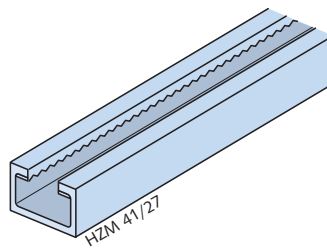
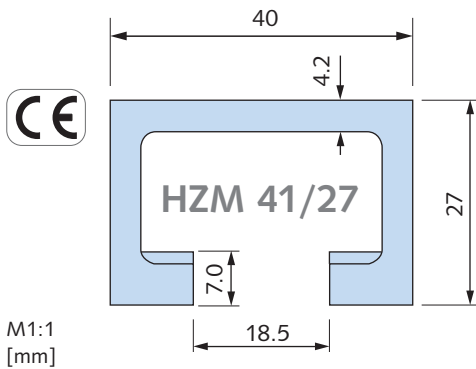

Double channel on request  
profile data, → see page 62

Dimensions and cross section properties									Load capacities				
		Length	Weight	Cross section area	Moment of inertia		Section modulus		Max. point-load bearing capacity		Bending load capacity at span L		
		[mm]	[kg/m]	[cm <sup>2</sup> ]	I <sub>y</sub>	I <sub>z</sub>	W <sub>y</sub>	W <sub>z</sub>	F <sub>z</sub> ①	≤ e <sub>w</sub>	F [kN]		
Material	Order no.				[cm <sup>4</sup> ]	[cm <sup>4</sup> ]	[cm <sup>3</sup> ]	[cm <sup>3</sup> ]	[kN]	[cm]	0.5 m	1.0 m	1.5 m
HZM 41/27	0284.												
WB	090-00002	6070	3.38	4.31	3.90	9.49	2.57	4.75	F <sub>z,Rd</sub>		F <sub>Rd</sub>		
									25.0	20.0	9.5	3.7	1.6
FV	090-00001								allow. F <sub>z</sub>		allow. F		
									17.8		6.8	2.6	1.2

① F<sub>z</sub> = max. load bearing capacity of the channel lips – see also page 69

### Accessories

**VUS 40/25**  
Washer  
→ see page 58

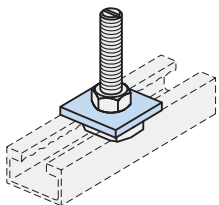

**SIC 38/23**  
Locking washer  
→ see page 58

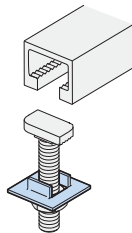

**SDM - 36/6**  
Rubber vibration absorber  
→ see MT-FFC catalogue

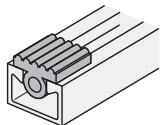

### Further design properties

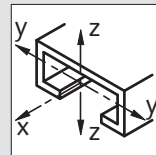

Cross section data  
→ page 62

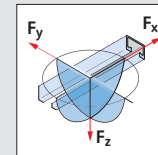

Point-load capacities  
→ pages 69

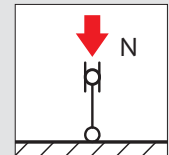

Flexural buckling  
→ page 72



# HALFEN INDUSTRIAL TECHNOLOGY

## Framing Channels – Heavy Duty Framing System

### Framing channel HZM 38/23

HZM 38/23 hot-rolled, serrated 

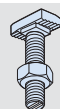

Suitable HALFEN Bolts HZS 38/23 and HS 38/17 → see page 34

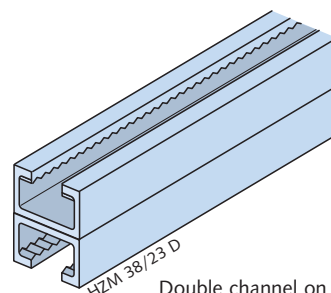
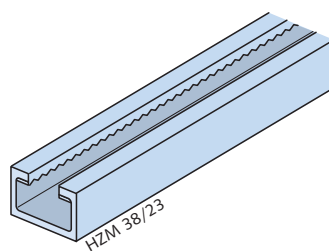
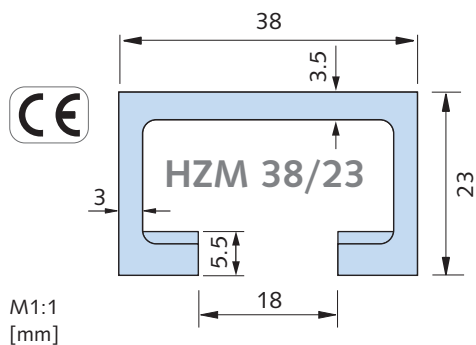

Double channel on request  
profile data, → see page 62

Dimensions and cross section properties									Load capacities				
Material	Order no.	Length	Weight	Cross section area	Moment of inertia		Section modulus		Max. point-load bearing capacity		Bending load capacity at span L		
		[mm]	[kg/m]	[cm <sup>2</sup> ]	$I_y$	$I_z$	$W_y$	$W_z$	$F_z$ ①	$\leq e_w$	F [kN]		
					[cm <sup>4</sup> ]	[cm <sup>4</sup> ]	[cm <sup>3</sup> ]	[cm <sup>3</sup> ]	[kN]	[cm]	L [m]		
											0.5 m	1.0 m	1.5 m
HZM 38/23	0284.								$F_{z,Rd}$		$F_{Rd}$		
WB	060-00001								18.0	20	5.9	2.0	0.9
FV	060-00003	6070	2.43	3.09	2.11	6.17	1.59	3.25	allow. $F_z$		allow. F		
A4	060-00002								12.8		4.2	1.4	0.6

①  $F_z$  = max. load bearing capacity of the channel lips – see also page 69

### Accessories

#### VUS 40/25

Washer  
→ see page 58

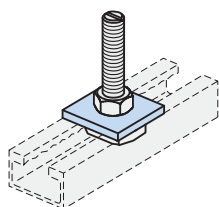

#### SIC 38/23

Locking washer  
→ see page 58

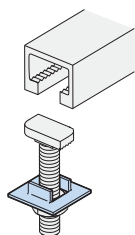

#### SDM - 36/6

Rubber vibration absorber  
→ see MT-FFC catalogue

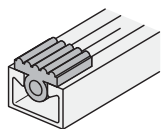

### Further design properties

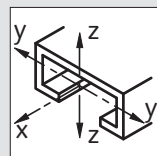

Cross section data  
→ page 62

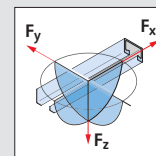

Point-load capacities  
→ pages 69

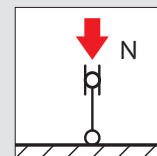

Flexural buckling  
→ page 72

# HALFEN INDUSTRIAL TECHNOLOGY

## Framing Channels – Heavy Duty Framing System

### HALFEN Bolts HZS 38/23 and HS 38/17

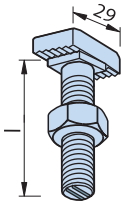

**HZS 38/23**  
HALFEN Bolt  
serrated incl. nut

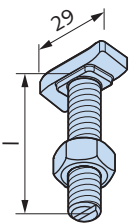

**HS 38/17**  
HALFEN Bolt  
incl. nut

**i On request**  
HCR High corrosion resistant stainless steel for HS 38/17

HZS 38/23 available bolts					
Length l [mm]	M12	M16	Length l [mm]	M12	M16
30	GVs8.8	GVs8.8	100	GVs8.8	GVs8.8
40	GVs8.8	GVs8.8	125	GVs8.8	GVs8.8
50	GVs8.8	GVs8.8	150	GVs8.8	GVs8.8
60	GVs8.8	GVs8.8 A4-70	200	-	GVs8.8
80	GVs8.8	GVs8.8 A4-70	300	-	GVs8.8

HS 38/17 available bolts								
Length l [mm]	M10	M12	M16	Length l [mm]	M10	M12	M16	
20	GVs4.6	GVs4.6	-	60	GVs4.6 A4-70	GVs4.6 GVs8.8 A2-70 A4-70	GVs4.6 FV8.8	
25	-	A4-70	-		70	-	FV8.8	-
30	GVs4.6 FV 4.6 A4-70	GVs4.6 FV4.6 A2-70 A4-70	GVs4.6 FV4.6 A4-50	80		GVs4.6	GVs4.6 A4-70	GVs4.6 FV4.6 A4-50
	40	GVs4.6 A4-70	GVs4.6 FV4.6 A2-70 A4-70		GVs4.6 FV4.6 A4-50	100	GVs4.6	GVs4.6 A4-50
50		GVs4.6 FV4.6 A4-70	GVs4.6 FV4.6 A2-70 A4-70	GVs4.6 FV4.6 A4-50 A4-70	125		-	GVs4.6
	200	GVs4.6	GVs4.6	GVs4.6	150	GVs4.6	GVs4.6	GVs4.6 A4-50
		-	GVs4.6	GVs4.6	200	-	GVs4.6	GVs4.6

① on request

Load bearing capacities for HALFEN Bolts ①										
Thread $\phi$	Load capacities for HALFEN Bolts				Max. load capacity per bolt in channel longitudinal direction		Recommended torque			
	F [kN] ①				F <sub>x</sub> [kN] ①		T <sub>inst</sub> [Nm]			
38/23	HZS				HZS		HZS			
	8.8				A4-70		For all strength classes			
	M12	F <sub>Rd</sub>	27.2	-	16.8		8.8	A4-70		
		allow. F	19.4	-	12.0			80	-	
M16	F <sub>Rd</sub>	50.5	33.0	16.8		120	120			
	allow. F	36.1	23.6	12.0						
38/17	HS				HS		HS			
	4.6 8.8 A2-50; A4-50 A2-70; A4-70				-		4.6 8.8 A2-50; A4-50 A2-70; A4-70			
	M10	F <sub>Rd</sub>	8.3	18.6	7.3	15.6	15	40	15	30
		allow. F	5.9	13.3	5.2	11.2		25	70	25
	M12	F <sub>Rd</sub>	12.1	27.0	10.6	22.7	65		180	60
		allow. F	8.6	19.3	7.6	16.2		HALFEN Bolts HS are not suitable for longitudinal loads in serrated channels!		
	M16	F <sub>Rd</sub>	22.6	50.2	19.8	42.2				
		allow. F	16.1	35.9	14.1	30.2				

① Note: do not exceed the max. channel load bearing capacity

In case of simultaneous loading in all directions (longitudinal -x, transverse -y, central tension -z) the resultant load must not exceed the load bearing capacity given in the table.



$$\sqrt{F_x^2 + F_y^2 + F_z^2} \leq \text{allow. F}$$

resp.

$$\sqrt{F_{x,Ed}^2 + F_{y,Ed}^2 + F_{z,Ed}^2} \leq F_{Rd}$$

F<sub>x</sub>, F<sub>y</sub>, F<sub>z</sub> = existing loads  
allow. F = allowable load bearing capacity of the bolt

resp.  
F<sub>x,Ed</sub>, F<sub>y,Ed</sub>, F<sub>z,Ed</sub> = design values of action  
F<sub>Rd</sub> = design value of resistance

# HALFEN INDUSTRIAL TECHNOLOGY

## Framing Channels – Heavy Duty Framing System

### Framing channel HZM 29/20

HZM 29/20 hot-rolled, serrated 

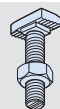
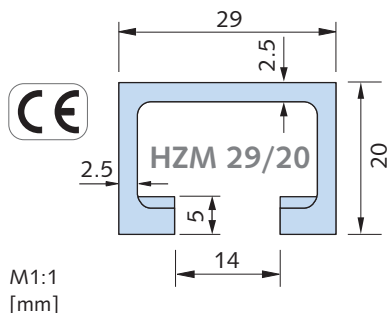

Suitable HALFEN Bolt HZS 29/20 and HS 28/15 → see page 36

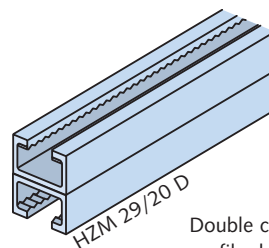
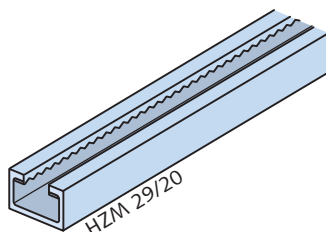

Double channel on request profile data, → see page 62

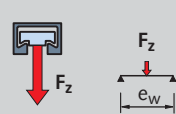
Dimensions and cross section properties									Load capacities				
Material	Order no.	Length [mm]	Weight G [kg/m]	Cross section area A [cm <sup>2</sup> ]	Moment of inertia		Section modulus		Max. point-load bearing capacity		Bending load capacity at span L		
					$I_y$ [cm <sup>4</sup> ]	$I_z$ [cm <sup>4</sup> ]	$W_y$ [cm <sup>3</sup> ]	$W_z$ [cm <sup>3</sup> ]	$F_z$ ① [kN]	$\leq e_w$ [cm]	F [kN]		
HZM 29/20	0284.												
WB	050-00001	6070	1.55	1.98	1.02	2.42	0.91	1.67	$F_{z,Rd}$	15.0	$F_{Rd}$		
FV	050-00003								11.2		3.3	1.0	0.4
									allow. $F_z$	allow. F			
									8.0	2.4	0.7	0.3	

①  $F_z$  = max. load bearing capacity of the channel lips – see also page 69

### Accessories

**US DIN 9021**  
Washer  
→ see page 58

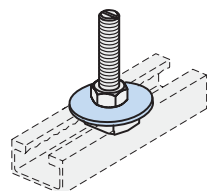

**SIC 29/20**  
Locking washer  
→ see page 58

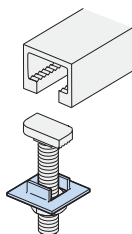

### Further design properties

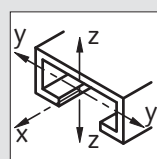

Cross section data  
→ page 62

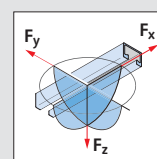

Point-load capacities  
→ pages 69

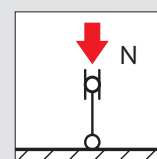

Flexural buckling  
→ page 72

# HALFEN INDUSTRIAL TECHNOLOGY

## Framing Channels – Heavy Duty Framing System

### HALFEN Bolts HZS 29/20 and HS 28/15

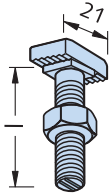

**HZS 29/20**  
HALFEN Bolt  
serrated incl. nut

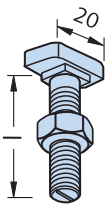

**HS 28/15**  
HALFEN Bolt incl.  
nut

**i On request**  
HCR High corrosion resistant  
stainless steel HCR for HS 28/15

HZS 29/20 available bolts									
Length l [mm]		M12		Length l [mm]		M12			
30		GVs8.8		125		GVs8.8			
40		GVs8.8		150		GVs8.8			
50		GVs8.8		200		GVs8.8			
60		GVs8.8		250		GVs8.8			
80		GVs8.8		300		GVs8.8			
100		GVs8.8							

HS 28/15 available bolts									
Length l [mm]	M6	M8	M10	M12	Length l [mm]	M6	M8	M10	M12
15	GVs4.6	GVs4.6	GVs4.6	-	50	-	GVs4.6	GVs4.6	GVs4.6
20	GVs4.6	GVs4.6	GVs4.6	-				FV 4.6	GVs4.6
		A2-70	A2-70	-	A4-70	GVs4.6			
25	GVs4.6	GVs4.6	GVs4.6	-	60	-	GVs4.6	GVs4.6	-
		A2-70	A2-70	-				GVs8.8	A4-70
30	GVs4.6	GVs4.6	GVs4.6	GVs4.6	80	-	GVs4.6	GVs4.6	GVs4.6
		A2-70	A2-70	FV 4.6				A4-70	A4-70
35	-	-	-	GVs4.6	100	-	GVs4.6	GVs4.6	-
				A4-70				A4-70	GVs4.6
40	GVs4.6	GVs4.6	GVs4.6	-	125	-	-	GVs4.6	-
			FV8.8	-				GVs4.6	-
40	GVs4.6	GVs4.6	GVs4.6	-	150	-	-	GVs4.6	-
			A2-70	-				GVs4.6	-
40	GVs4.6	GVs4.6	GVs4.6	-	200	-	-	GVs4.6	-
			A2-70	-				GVs4.6	-
			A4-70	-				A4-50	-

Load bearing capacities for HALFEN Bolts ①										
Thread $\phi$	Load capacities for HALFEN Bolts				Max. load capacity per bolt in channel longitudinal direction		Recommended torque			
	 F [kN] ①				 F <sub>x</sub> [kN] ①		 T <sub>inst</sub> [Nm]			
29/20	HZS				HZS		HZS			
	8.8				8.8		8.8			
M12	F <sub>Rd</sub>	27.2			11.2		80			
	allow. F	19.4			8.0					
28/15	HS				HS		HS			
		4.6	8.8	A2/A4-50	A2/A4-70	-	4.6	8.8	A2/A4-50	A2/A4-70
M6	F <sub>Rd</sub>	2.9	-	-	-	HALFEN Bolts HS are not suitable for longitudinal loads in serrated channels!	3	-	3	-
	allow. F	2.1	-	-	-		8	20	8	15
M8	F <sub>Rd</sub>	5.3	11.7	-	-		15	40	15	30
	allow. F	3.8	8.3	-	5.5		25	70	25	50
M10	F <sub>Rd</sub>	8.3	18.6	7.3	15.6					
	allow. F	5.9	13.3	5.2	11.2					
M12	F <sub>Rd</sub>	12.1	-	-	-					
	allow. F	8.6	-	-	-					

① Note: do not exceed the max. channel load bearing capacity

In case of simultaneous loading in all directions (longitudinal -x, transverse -y, central tension -z) the resultant load must not exceed the load bearing capacity given in the table.

$$\sqrt{F_x^2 + F_y^2 + F_z^2} \leq \text{allow. F}$$

resp.

$$\sqrt{F_{x,Ed}^2 + F_{y,Ed}^2 + F_{z,Ed}^2} \leq F_{Rd}$$

F<sub>x</sub>, F<sub>y</sub>, F<sub>z</sub> = existing loads  
 allow. F = allowable load bearing capacity of the bolt  
 resp.  
 F<sub>x,Ed</sub>, F<sub>y,Ed</sub>, F<sub>z,Ed</sub> = design values of action  
 F<sub>Rd</sub> = design value of resistance

# HALFEN INDUSTRIAL TECHNOLOGY

## Framing channels – Medium duty system

### Framing channels HM 41/41 and HL 41/41

HM 41/41 – HL 41/41 cold-rolled

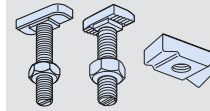
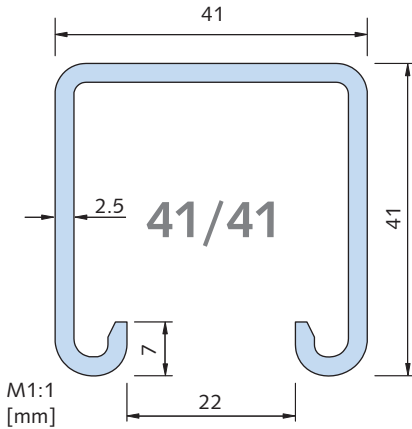

Suitable HALFEN Bolts HS 41/41, HZS 41/41, HZS 41/22 and locking plate → see page 44 – 45

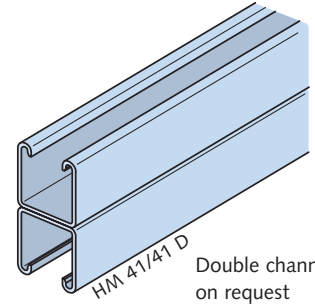
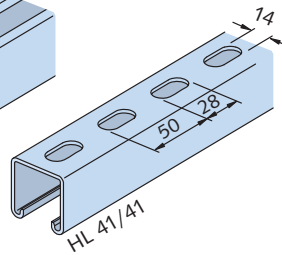
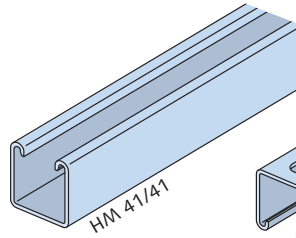

Dimensions and cross section properties								Load capacities					
Material	Order no.	Length	Weight	Cross section area	Moment of inertia		Section modulus		Max. point-load bearing capacity		Bending load capacity at span L		
		[mm]	G [kg/m]	A [cm <sup>2</sup> ]	I <sub>y</sub> [cm <sup>4</sup> ]	I <sub>z</sub> [cm <sup>4</sup> ]	W <sub>y</sub> [cm <sup>3</sup> ]	W <sub>z</sub> [cm <sup>3</sup> ]	F <sub>z</sub> ① [kN]	≤ e <sub>w</sub> [cm]	F [kN]		
											0.5 m	1.0 m	1.5 m
HM 41/41	0280.	6000	2.67	3.4	7.47	9.44	3.24	4.57	F <sub>z,Rd</sub>	49.0	F <sub>Rd</sub>		
WB	080-00001								7.8		7.8	3.9	
SV	080-00002								allow. F <sub>z</sub>		allow. F		
FV	080-00003								5.6		5.6	2.8	
A4	080-00004								5.6		5.6	1.9	
HL 41/41	0281.	6000	2.46	2.98	6.07	9.16	2.84	4.43	F <sub>z,Rd</sub>	42.0	F <sub>Rd</sub>		
WB	010-00001								7.8		6.6	3.2	
SV	010-00003								allow. F <sub>z</sub>		allow. F		
FV	010-00002								5.6		4.7	2.3	
A4	010-00004								5.6		4.7	1.6	
HM 41/41 D	0280.	6000	5.34	6.81	37.60	18.88	9.10	9.14	F <sub>z,Rd</sub>	132.0	F <sub>Rd</sub>		
WB	150-00001								7.8		10.6	7.1	
FV	150-00003								allow. F <sub>z</sub>		allow. F		
A4	150-00002								5.6		7.6	5.1	
									5.6		7.6	3.8	

① F<sub>z</sub> = max. load bearing capacity of the channel lips

### Accessories

HPE 41/41 Channel end cap  
→ see page 55

PA - 41 Channel cover  
→ see page 55

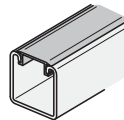
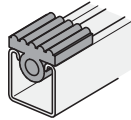
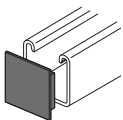

SDM - 41/8 Rubber vibration absorber  
→ see MT-FFC catalogue

### Further design properties

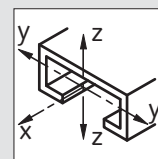

Cross section data  
→ pages 64, 66

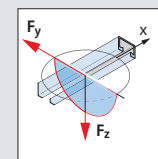

Point-load capacities  
→ page 68

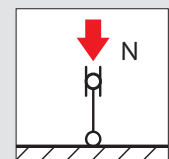

Flexural buckling  
→ page 73

# HALFEN INDUSTRIAL TECHNOLOGY

## Framing channels – Medium duty system

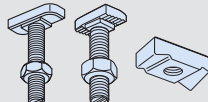

### Framing channel HZM 41/41 and HZL 41/41

HZM 41/41 – HZL 41/41 cold-rolled, serrated 

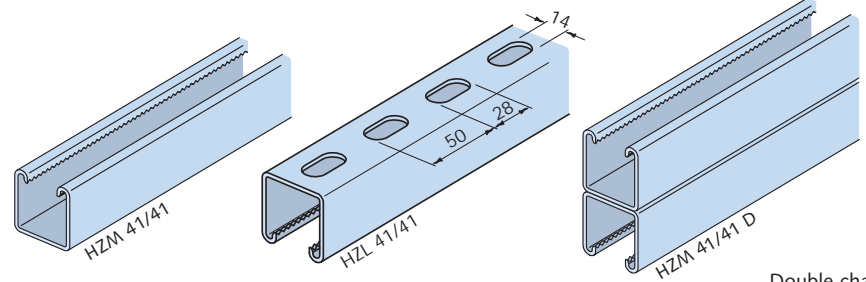
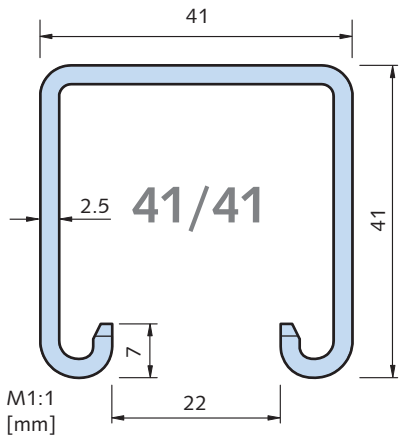
 Suitable HALFEN Bolts HS 41/41, HZS 41/41, HZS 41/22 and locking plates → see pages 44-45

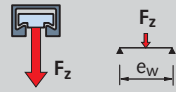

Double channel on request

Dimensions and cross section properties									Load capacities				
Material	Order no.	Length [mm]	Weight G [kg/m]	Cross section area A [cm <sup>2</sup> ]	Moment of inertia [cm <sup>4</sup> ]		Section modulus [cm <sup>3</sup> ]		Max. point-load bearing capacity		Bending load capacity at span L		
					$I_y$	$I_z$	$W_y$	$W_z$	$F_z$ ① [kN]	$\leq e_w$ [cm]	F [kN]		
													
HZM 41/41	0284.	6000	2.63	3.35	7.34	9.37	3.15	4.54	$F_{z,Rd}$	47.0	0.5 m	1.0 m	1.5 m
WB	010-00001								$F_{Rd}$				
FV	010-00002								7.7		3.8	2.6	
A4	010-00003								allow. F				
									5.6		5.5	2.7	1.8
HZL 41/41	0283.	6000	2.46	2.90	5.87	9.04	2.69	4.38	$F_{z,Rd}$	41.0	0.5 m	1.0 m	1.5 m
WB	010-00001								$F_{Rd}$				
FV	010-00002								6.3		3.2	2.1	
A4	010-00003								allow. F				
									5.6		4.5	2.3	1.5
HZM 41/41 D	0284.	6000	5.27	6.7	36.45	18.73	8.83	9.07	$F_{z,Rd}$	126.0	1.0 m	1.5 m	2.0 m
WB	030-00001								$F_{Rd}$				
FV	030-00002								10.3		6.9	5.2	
A4	030-00003								allow. F				
									5.6		7.4	4.9	3.7

①  $F_z$  = max. load bearing capacity of the channel lips

### Accessories

HPE 41/41 Channel end cap  
→ see page 55

PA - 41 Channel cover  
→ see page 55

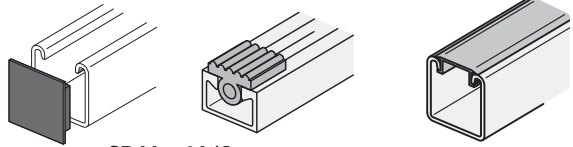

SDM - 41/8  
Rubber vibration absorber  
→ see catalogue MT-FFC

### Further design properties

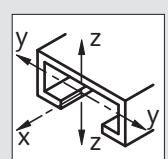

Cross section data  
→ pages 64, 66

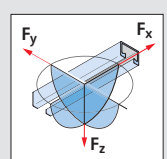

Point-load capacities  
→ page 68

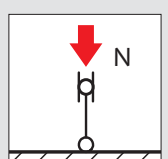

Flexural buckling  
→ page 73

# HALFEN INDUSTRIAL TECHNOLOGY

## Framing channels – Medium duty system

### Framing channel HM 41/62 and HL 41/62

HM 41/62 – HL 41/62 cold-rolled

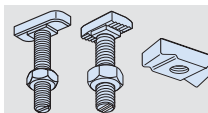
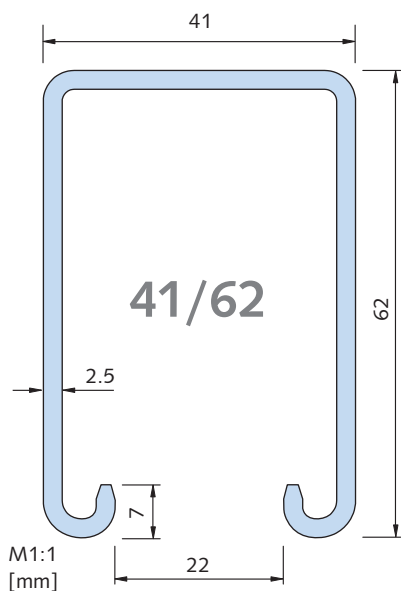

Suitable HALFEN Bolts HS 41/41, HZS 41/41, HZS 41/22 and locking plates → see pages 44–45

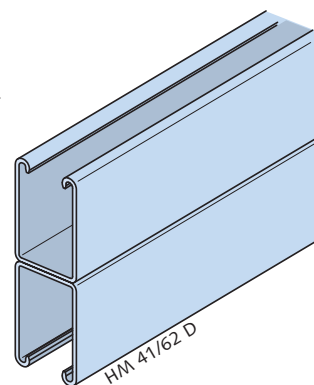
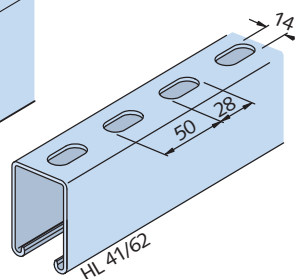
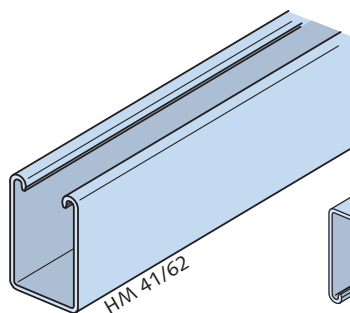

Note, span L: Constructive measures are required to prevent failure caused by bulging, twisting and buckling

Double channel on request

Dimensions and cross section properties								Load capacities					
Material	Order no.	Length [mm]	Weight G [kg/m]	Cross section area A [cm <sup>2</sup> ]	Moment of inertia I <sub>y</sub> [cm <sup>4</sup> ]		Section modulus W <sub>y</sub> [cm <sup>3</sup> ]	Max. point-load bearing capacity		Bending load capacity at span L			
								F <sub>z</sub> ① [kN]	≤ e <sub>w</sub> [cm]		1.0 m	2.0 m	3.0 m
HM 41/62	0280.												
WB	140-00002	6000	3.48	4.44	20.96	13.34	6.21	6.46	F <sub>z,Rd</sub>	92.0	F <sub>Rd</sub>		
FV	140-00003								7.8		7.4	3.7	2.2
								allow. F <sub>z</sub>			allow. F		
								5.6			5.3	2.6	1.6
HL 41/62	0281.										1.0 m	2.0 m	3.0 m
WB	040-00001	6000	3.14	3.99	17.27	13.03	5.47	6.31	F <sub>z,Rd</sub>	81.0	F <sub>Rd</sub>		
SV	040-00003								7.8		6.3	3.1	1.8
FV	040-00002								allow. F <sub>z</sub>		allow. F		
								5.6			4.5	2.2	1.3
HM 41/62 D	0280.										1.0 m	1.5 m	2.0 m
WB	170-00001	6000	6.97	8.88	112.88	26.68	18.21	12.92	F <sub>z,Rd</sub>	269.0	F <sub>Rd</sub>		
FV	170-00002								7.8		21.4	14.3	10.7
								allow. F <sub>z</sub>			allow. F		
								5.6			15.3	10.2	7.7

① F<sub>z</sub> = max. load bearing capacity of the channel lips

Accessories: PA - 41 Channel cover → see page 55

SDM - 41/8 Rubber vibration absorber, see Technical Product Information: "MT-FFC HALFEN Flexible Framing connections".

Further design properties: Cross section data → pages 64, 66



# HALFEN INDUSTRIAL TECHNOLOGY

## Framing channels – Medium duty system

### Framing channel HM 41/83 and HL 41/83

HM 41/83 – HL 41/83 cold-rolled

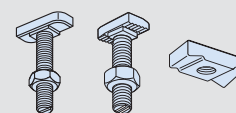
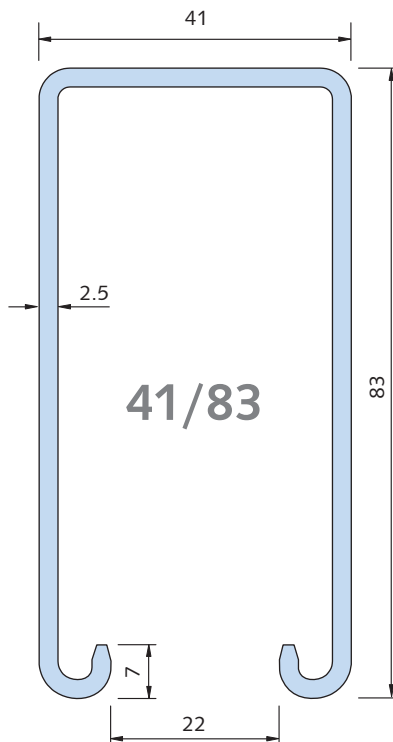
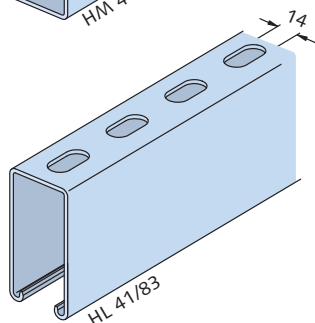
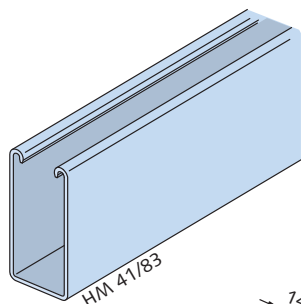

Suitable HALFEN Bolts HS 41/41, HZS 41/41, HZS 41/22 and locking plates → see pages 44–45

#### Further design properties

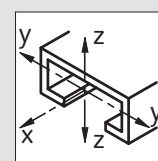

Cross section data  
→ pages 64, 66



Note on span L:  
Constructive measures are required to prevent failure caused by bulging, twisting and buckling

Dimensions and cross section properties									Load capacities					
Material	Order no.	Length [mm]	Weight G [kg/m]	Cross section area A [cm <sup>2</sup> ]	Moment of inertia [cm <sup>4</sup> ]		Section modulus [cm <sup>3</sup> ]		Max. point-load bearing capacity		Bending load capacity at span L			
HM 41/83	0280.	6000	4.29	5.47	43.82	17.22	9.91	8.34	$F_z$ ①	$\leq e_w$				
WB	130-00002								$F_{z,Rd}$					
SV	130-00001								7.8					
FV	130-00003								allow. $F_z$					
											1.0 m	2.0 m	3.0 m	
												$F_{Rd}$		
												11.7	5.9	3.9
												allow. F		
												8.4	4.2	2.8
HL 41/83	0281.	6000	3.93	5.02	37.07	16.93	8.85	8.20	$F_z$ ①	$\leq e_w$				
WB	030-00004								$F_{z,Rd}$					
SV	030-00006								7.8					
FV	030-00005								allow. $F_z$					
												1.0 m	2.0 m	3.0 m
													$F_{Rd}$	
												10.2	5.2	3.4
												allow. F		
												7.3	3.7	2.4

①  $F_z$  = max. load bearing capacity of the channel lips

#### Accessories

**PA - 41**  
Channel cover  
→ see page 55

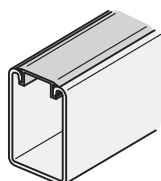

**SDM - 41/8**  
Rubber vibration absorber  
→ see MT-FFC catalogue

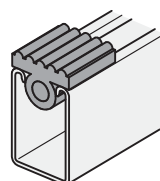

# HALFEN INDUSTRIAL TECHNOLOGY

## Framing channels – Medium duty system

### Framing channel HZL 63/63

HZL 63/63 cold-rolled, serrated 

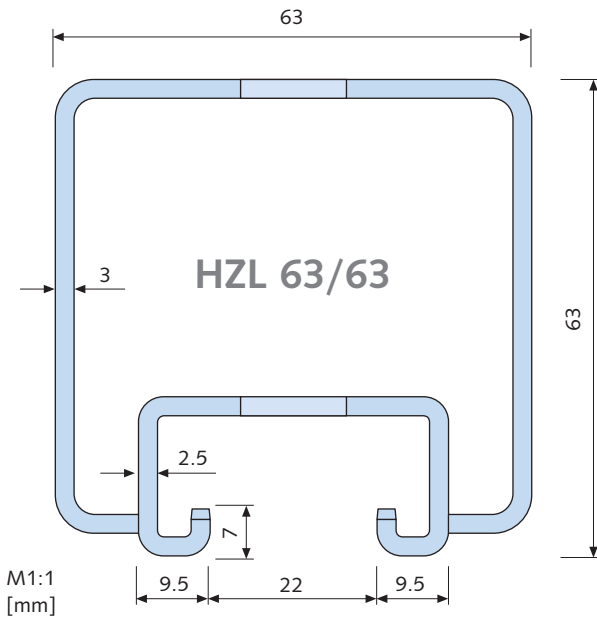

Standard profile for HALFEN Powerclick System 63. More information on the HALFEN Framing System "Powerclick" can be found in Technical Product Information "HALFEN Powerclick PC63".

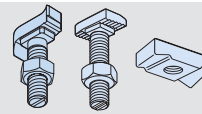

Suitable HALFEN Bolts HS 41/41, HZS 41/41, HZS 41/22 and locking plates → see pages 44–45

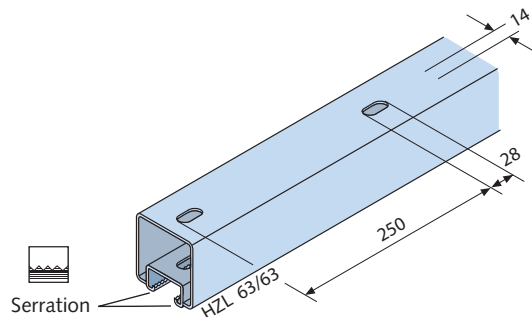

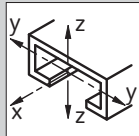
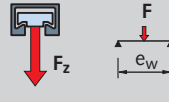
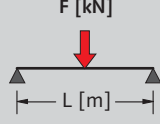
Dimensions and cross section properties								Load capacities					
		Length	Weight	Cross section area	Moment of inertia		Section modulus		Max. point-load bearing capacity		Bending load capacity at span L		
													
Material	Order no.	[mm]	G [kg/m]	A [cm <sup>2</sup> ]	I <sub>y</sub> [cm <sup>4</sup> ]	I <sub>z</sub> [cm <sup>4</sup> ]	W <sub>y</sub> [cm <sup>3</sup> ]	W <sub>z</sub> [cm <sup>3</sup> ]	F <sub>z</sub> ① [kN]	≤ e <sub>w</sub> [cm]	F [kN]		
											0.5 m	1.0 m	1.5 m
HZL 63/63	0283.								F <sub>z,Rd</sub>	134.0	F <sub>Rd</sub>		
FV	030-00001	3000	6.35	7.09	33.07	42.95	10.06	13.63	7.8		23.1	11.5	7.7
									allow. F <sub>z</sub>			allow. F	
FV	030-00003	6000							5.6		16.5	8.2	5.5

① F<sub>z</sub> = max. load bearing capacity of the channel lips

### Accessories

**HPE 63/63**  
Channel end cap  
→ see page 55

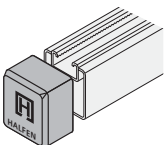

**PA - 41**  
Channel cover  
→ see page 55

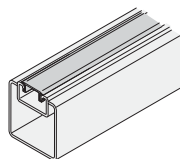

**SDM - 41/8**  
Rubber vibration absorber  
→ see catalogue MT-FFC

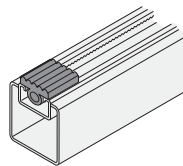

### Further design properties

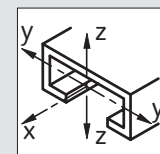

Cross section data  
→ page 66

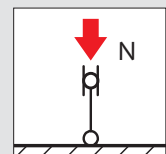

Flexural buckling  
→ page 73

# HALFEN INDUSTRIAL TECHNOLOGY

## Framing channels – Medium duty system

### Framing channel HM 41/22 and HL 41/22

HM 41/22 – HL 41/22 cold-rolled

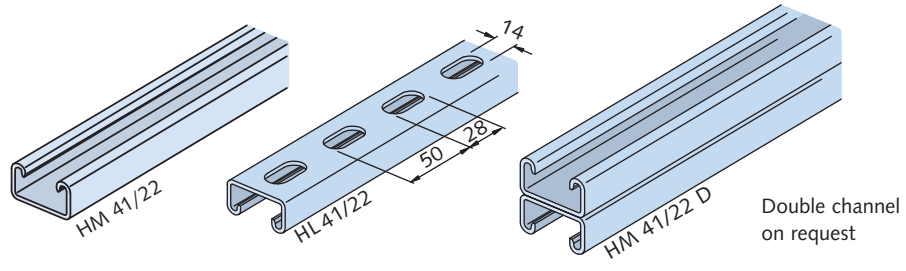
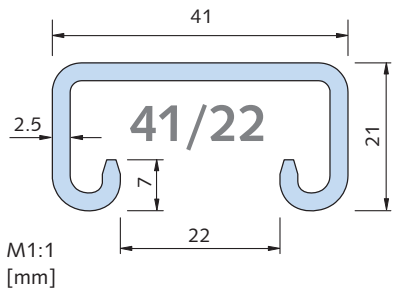
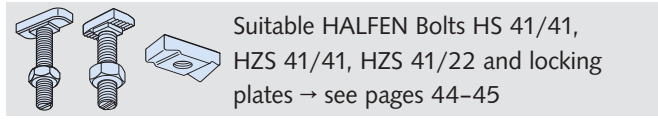

Dimensions and cross section properties									Load capacities									
Material	Order no.	Length	Weight	Cross section area	Moment of inertia		Section modulus		Max. point-load bearing capacity		Bending load capacity at span L							
		[mm]	G [kg/m]	A [cm <sup>2</sup> ]	$I_y$ [cm <sup>4</sup> ]	$I_z$ [cm <sup>4</sup> ]	$W_y$ [cm <sup>3</sup> ]	$W_z$ [cm <sup>3</sup> ]	$F_z$ ① [kN]	$e_w$ [cm]								
HM 41/22	0280.	6000	1.86	2.37	1.28	5.56	1.05	2.69	$F_z$	15.0	0.5 m	1.0 m	1.5 m					
WB	120-00001								$F_{z,Rd}$					$F_{Rd}$				
SV	120-00002								7.8						allow. $F_z$	2.7	1.2	0.5
FV	120-00003								5.6							allow. F		
A4	120-00004								5.6						1.9	0.9	0.4	
HL 41/22	0281.	6000	1.57	1.95	0.99	5.27	0.89	2.55	$F_z$	12.0	0.5 m	1.0 m	1.5 m					
WB	020-00001								$F_{z,Rd}$					$F_{Rd}$				
SV	020-00003								7.8						allow. $F_z$	2.2	1.0	0.4
FV	020-00002								5.6							allow. F		
A4	020-00004								5.6						1.6	0.7	0.3	
HM 41/22 D	0280.	6000	3.73	4.75	6.02	11.11	2.91	5.38	$F_z$	42.0	1.0 m	1.5 m	2.0 m					
WB	160-00001								$F_{z,Rd}$					$F_{Rd}$				
FV	160-00002								7.8						allow. $F_z$	3.5	2.3	1.4
A4	160-00003								5.6							allow. F		
									5.6						2.5	1.7	1.0	

①  $F_z$  = max. load bearing capacity of the channel lips

### Accessories

**HPE 41/22**  
Channel end cap  
→ see page 55

**PA - 41**  
Channel cover  
→ see page 55

**SDM - 41/8**  
Rubber vibration absorber  
→ see catalogue MT-FFC

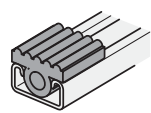
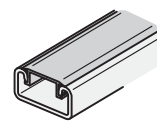
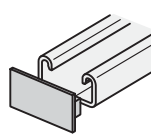

### Further design properties

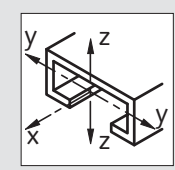

Cross section data  
→ page 64, 66

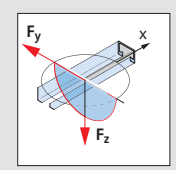

Point-load capacities  
→ page 68

# HALFEN INDUSTRIAL TECHNOLOGY

## Framing channels – Medium duty system

### Framing channel HZM 41/22 and HZL 41/22

HZM 41/22 – HZL 41/22 cold-rolled, serrated 

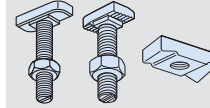

Suitable HALFEN Bolts HS 41/41, HZS 41/41, HZS 41/22 and locking plates → see pages 44–45

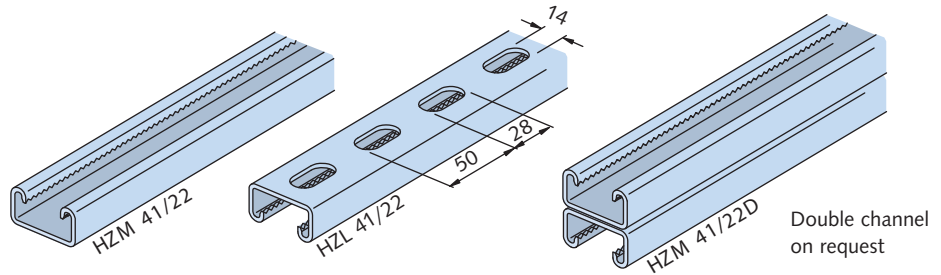
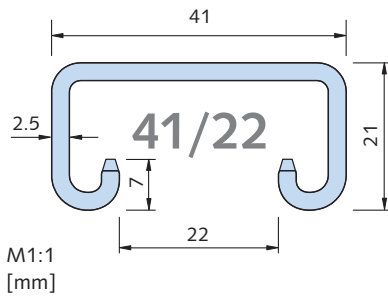

Dimensions and cross section properties									Load capacities				
Material	Order no.	Length	Weight	Cross section area	Moment of inertia		Section modulus		Max. point-load bearing capacity		Bending load capacity at span L		
			G	A	$I_y$	$I_z$	$W_y$	$W_z$	$F_z$ ①	$\leq e_w$			
		[mm]	[kg/m]	[cm <sup>2</sup> ]	[cm <sup>4</sup> ]	[cm <sup>4</sup> ]	[cm <sup>3</sup> ]	[cm <sup>3</sup> ]	[kN]	[cm]	F [kN]		
											L [m]		
HZM 41/22	0284.										0.5 m	1.0 m	1.5 m
WB	020-00001	6070	1.83	2.33	1.26	5.48	1.03	2.66	$F_{z,Rd}$	14.0	$F_{Rd}$		
FV	020-00002								7.8		2.7	1.2	0.5
A4	020-00003								allow. $F_z$		allow. F		
									5.6		1.9	0.8	0.4
HZL 41/22											0.5 m	1.0 m	1.5 m
WB	020-00001	6000	1.57	1.87	0.97	5.15	0.86	2.49	$F_{z,Rd}$	12.0	$F_{Rd}$		
FV	020-00002								7.8		2.1	0.8	0.4
A4	020-00003								allow. $F_z$		allow. F		
									5.6		1.5	0.6	0.3
HZM 41/22 D											1.0 m	1.5 m	2.0 m
WB	040-00001	6070	3.58	4.65	5.83	10.97	2.82	5.31	$F_{z,Rd}$	42.0	$F_{Rd}$		
FV	040-00002								7.8		3.4	2.2	1.4
A4	040-00003								allow. $F_z$		allow. F		
									5.6		2.4	1.6	1.0

①  $F_z$  = max. load bearing capacity of the channel lips

### Accessories

**HPE 41/22**  
Channel end cap  
→ see page 55

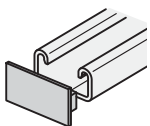

**PA - 41**  
Channel cover  
→ see page 55

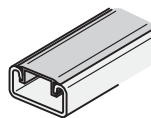

**SDM - 41/8**  
Rubber vibration absorber  
→ see catalogue MT-FFC

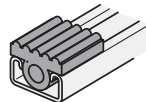

### Further design properties

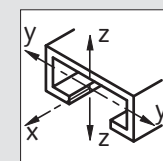

Cross section data  
→ pages 64, 66

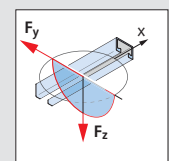

Point-load capacities  
→ page 68

# HALFEN INDUSTRIAL TECHNOLOGY

## Framing channels – Medium duty system

### HALFEN Bolts HZS 41/41, HZS 41/22 and HS 41/41

HALFEN Bolts for all 41/... channels:

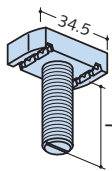

**HZS 41/41**  
HALFEN Bolt serrated,  
order nut separately

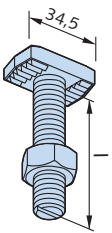

**HZS 41/22**  
HALFEN Bolt serrated,  
incl. nut  
for serrated channels  
41/41, 41/22 and  
63/63

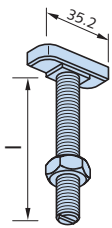

**HS 41/41**  
HALFEN Bolt  
incl. nut

HZS 41/41 available bolts					
Length l [mm]	M6	M8	M10	M12	M16 ①②
30	ZL	ZL	ZL	ZL	-
50	-	ZL	ZL	ZL	-
63	-	-	-	-	ZL
75	-	-	ZL	ZL	-
100	-	-	-	ZL FV4.6	-
102	-	-	-	-	ZL ③

- ① Diameter M16 is not compatible with profile 41/22  
 ② Diameter M16 can only be inserted into the slot from the channel end  
 ③ On request  
 ZL = zinc flake coating

HZS 41/22 available bolts		
Length l [mm]	M12	M16
35	FV8.8 A4-50	A4-50 -
50	FV8.8 A4-50	FV8.8 A4-50
80	A4-50	-
100	-	FV8.8

HS 41/41 available bolts		
Length l [mm]	M10	M12
35	FV4.6 A4-70	FV4.6 A4-70
50	-	FV4.6

#### Torques for HALFEN Bolts ①

Thread $\varnothing$	Recommended torques $T_{inst}$ [Nm]				
	HZS 41/41 Steel	HZS 41/22 8.8	HZS 41/22 A4-50	HS 41/41 4.6	HS 41/41 A4-70
M6	12	-	-	-	-
M8	28	-	-	-	-
M10	55	-	-	15	15
M12	60	50	50	25	25
M16	125	80	80	-	-

#### Load capacities for 41/... HALFEN Bolts

Thread $\varnothing$	41/...	Load bearing capacities per bolt for centric tension for all 41/.. and 63/.. profiles $F_z$ [kN]					Recommended load capacity per HALFEN Bolt in channel longitudinal direction $F_x$ [kN]				
		HZS 41/41 Steel	HZS 41/22 8.8	HZS 41/22 A4-50	HS 41/41 4.6	HS 41/41 A4-70	HZS 41/41 ③ Steel	HZS 41/22 8.8	HZS 41/22 A4-50	HZS 41/41 Steel	HZS 41/22 A4-50
M6	$F_{Rd}$	7.0	-	-	-	-	3.1	-	-	1.4	-
	allow. F	5.0	-	-	-	-	2.2	-	-	1.0	-
M8	$F_{Rd}$	8.4	-	-	-	-	5.6	-	-	3.4	-
	allow. F	6.0	-	-	-	-	4.0	-	-	2.4	-
M10	$F_{Rd}$	9.8	-	-	9.0	9.0	7.0	-	-	4.9	-
	allow. F	7.0	-	-	6.4	6.4	5.0	-	-	3.5	-
M12	$F_{Rd}$	9.8	9.8	9.8	11.2	13.0	7.0	7.0	-	5.6	2.4
	allow. F	7.0	7.0	7.0	8.0	9.3	5.0	5.0	5.0	4.0	1.7
M16	$F_{Rd}$	16.8 ①②	16.8	16.8	-	-	5.6 ①②	7.0	7.0	5.6 ①②	5.6
	allow. F	12.0 ①②	12.0	12.0	-	-	4.0 ①②	5.0	5.0	4.0 ①②	4.0

- ① Diameter M16 is not compatible with 41/22  
 ② Diameter M16 can only be inserted into the slot from the channel end  
 ③ HZS 41/41 M16 × 102 no serration

# HALFEN INDUSTRIAL TECHNOLOGY

## Framing channels – Medium duty system

### Locking plates GWP 41/41 - SN, - SH, GWP 41/22

#### GWP 41/41

Locking plate for all 41 channels and 63/63 channels

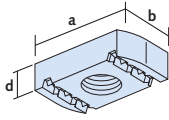

#### GWP 41/41 SH

Locking plate with long spring for 41/41 channel

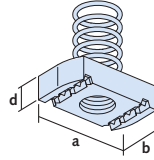

#### GWP 41/41 SN

Locking plate with short spring for 41/22 and 63/63 channels

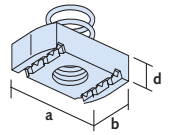

#### GWP 41/41 available plates

FV	GV	A4	d [mm]	b [mm]	a [mm]
–	M6	M6	6	20	34.5
M8	M8	M8	8/6		
M10	M10	M10	9	30	34.5
FM12	FM12	FM12	12		
M12	M12	–	–	–	–
M16	–	M16	–	–	–

F = flat version, fits all 41 and 63 channels

#### GWP 41/41 SH available plates

GV	d [mm]	b [mm]	a [mm]
M6	6	20	34.5
M8	8		
M10	9	30	34.5
M12	12		

#### GWP 41/41 SN available plates

GV	d [mm]	b [mm]	a [mm]
M6	6	20	34.5
M8	8		
M10	9	30	34.5
F M12	–		

F = flat version, fits all 41 and 63 channels

#### GWP 41/22

Locking plate for serrated channels 41/22 and 41/41

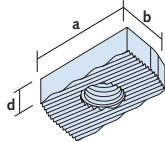

#### GWP 41/22 available plates

GV	A4	d [mm]	b [mm]	a [mm]
M6	–	7.5	20	34.7
M8	M8			
M10	M10	–	–	–
M12	M12	–	–	–
M16	M16	–	–	–

#### Torques for 41/... locking plates

41/...	Thread $\varnothing$	Recommended torques $T_{inst}$ [Nm]			
		GWP 41/41 Steel	GWP 41/41 A4	GWP 41/22 Steel	GWP 41/22 A4
		M6	12	6.5	12
M8	28	16.0	28	16.0	
M10	55	31.5	55	31.5	
M12	75	–	50	50	
FM12	60	55	–	–	
M16	125	125	80	80	

#### Load capacities for 41/... locking plates

Thread $\varnothing$	41/...	load bearing capacities for centric tension for all 41 and 63 channels $F_z$ [kN]				Recommended load capacity for locking plates in channel longitudinal direction $F_x$ [kN]				
		GWP 41/41 Steel	GWP 41/41 A4	GWP 41/22 Steel	GWP 41/22 A4	GWP 41/41 Steel	GWP 41/41 A4	GWP 41/22 Steel	GWP 41/22 A4	GWP 41/41 Steel
M6	$F_{Rd}$	7.0	7.0	7.0	7.0	3.1	3.1	3.1	–	1.4
	allow. F	5.0	5.0	5.0	5.0	2.2	2.2	2.2	–	1.0
M8	$F_{Rd}$	8.4	8.4	8.4	8.4	5.6	5.6	5.6	5.6	3.4
	allow. F	6.0	6.0	6.0	6.0	4.0	4.0	4.0	4.0	2.4
M10	$F_{Rd}$	9.8	9.8	9.8	9.8	7.0	7.0	7.0	7.0	4.9
	allow. F	7.0	7.0	7.0	7.0	5.0	5.0	5.0	5.0	3.5
M12	$F_{Rd}$	12.6 ①	–	9.8	9.8	7.0 ①	–	7.0	7.0	7.0
	allow. F	9.0 ①	–	7.0	7.0	5.0 ①	–	5.0	5.0	5.0
FM12	$F_{Rd}$	9.8	9.8	–	–	7.0	7.0	–	–	5.6
	allow. F	7.0	7.0	–	–	5.0	5.0	–	–	4.0
M16 ①②	$F_{Rd}$	16.8 ①②	9.8 ①②	9.8	9.8	10.5 ①②	7.0 ①②	10.5	7.0	10.5 ①②
	allow. F	12.0 ①②	7.0 ①②	7.0	7.0	7.5 ①②	5.0 ①②	7.5	5.0	7.5 ①②

F = flat version, fits all 41 and 63 channels

① Not compatible with 41/22 and 63/63 channels

② M16 can only be inserted in the slot from the channel end

# HALFEN INDUSTRIAL TECHNOLOGY

## Framing channels – Light duty system

### Framing channel HM 36/36, HL 36/36 and HM 38/17

#### HM 36/36 – HL 36/36 cold-rolled

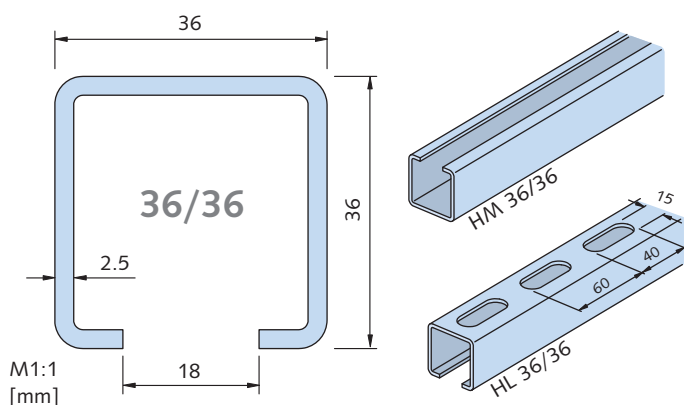

#### HM 38/17 cold-rolled

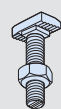
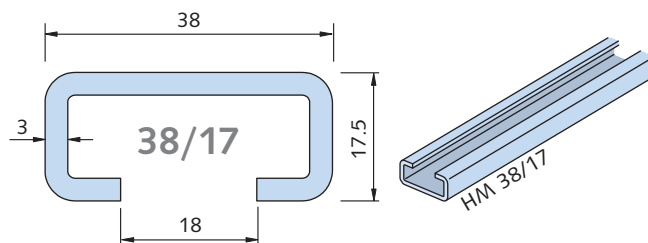

Suitable HALFEN Bolts  
HS 38/17 → see page 47

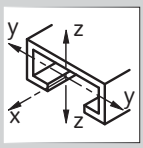
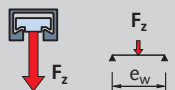
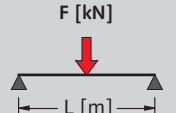
Dimensions and cross section properties									Load capacities				
Material	Order no.	Length [mm]	Weight G [kg/m]	Cross section area A [cm <sup>2</sup> ]	Moment of inertia 		Section modulus W <sub>y</sub> [cm <sup>3</sup> ] W <sub>z</sub> [cm <sup>3</sup> ]		Max. point-load bearing capacity 		Dending load capacity at span L 		
					I <sub>y</sub> [cm <sup>4</sup> ]	I <sub>z</sub> [cm <sup>4</sup> ]			F <sub>z</sub> ① [kN]	≤ e <sub>w</sub> [cm]	0.5 m	1.0 m	1.5 m
HM 36/36	0280.	6000	2.2	2.80	4.54	5.89	2.19	3.27	F <sub>z,Rd</sub>	44	F <sub>Rd</sub>		
WB	070-00001								6.2		5.5	2.7	1.8
FV	070-00002								allow. F <sub>z</sub>				
A4	070-00003								4.4		3.9	1.9	1.3
HL 36/36	0281.	6000	2.0	2.42	3.65	5.78	1.97	3.21	F <sub>z,Rd</sub>	36	F <sub>Rd</sub>		
WB	050-00001								6.2		4.5	2.2	1.5
FV	050-00002								allow. F <sub>z</sub>				
A4	050-00003								4.4		3.2	1.6	1.1
HM 38/17	0290.	6070	1.78	2.27	0.84	4.13	0.80	2.20	F <sub>z,Rd</sub>	11	F <sub>Rd</sub>		
WB	020-00001								6.7		2.10	0.84	0.42
FV	020-00002								allow. F <sub>z</sub>				
A2 ②	020-00003								4.8		1.5	0.6	0.3
A4	020-00004												

① F<sub>z</sub> = max. load bearing capacity of the channel lips

② Stainless steel A2 on request; Note: high corrosion resistant stainless steel HCR for HM 38/17 on request

#### Accessories

PA 18 H Channel cover → see page 55

HPE 36/36 Channel end cap for HM and HL 36/36

→ see page 55

SIC 38/17 Locking washer → see page 58

SDM - 36/6 Rubber vibration absorber → see MT-FFC catalogue

#### Further design properties

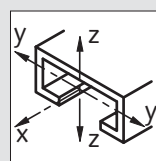

Cross section data  
→ pages 64, 66

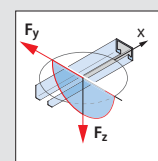

Point-load capacities  
→ page 70

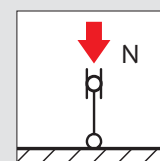

Flexural buckling  
→ page 73



# HALFEN INDUSTRIAL TECHNOLOGY

## Framing channels – Light duty system

### HALFEN Bolts HS 38/17

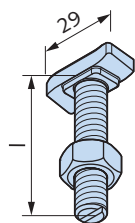

HS 38/17

HALFEN Bolt  
incl. nut



**On request**  
HCR High corrosion resistant  
stainless steel

HS 38/17 available bolts								
Length l [mm]	M10	M12	M16	Length l [mm]	M10	M12	M16	
20	GVs4.6	GVs4.6	-	60	GVs4.6 A4-70	GVs4.6 GVs8.8 A2-70 A4-70	GVs4.6 FV8.8	
25	-	A4-70	-		70	-	FV8.8	-
30	GVs4.6 FV 4.6 A4-70	GVs4.6 FV4.6 A2-70 A4-70	GVs4.6 FV4.6ⓐ A4-50	80		GVs4.6	GVs4.6 A4-70	GVs4.6 FV4.6 A4-50
	40	GVs 4.6 A4-70	GVs4.6 FV4.6 A2-70 A4-70		GVs4.6 FV4.6 A4-50	100	GVs4.6	GVs4.6 A4-50
50		GVs 4.6 FV4.6 A4-70	GVs4.6 FV4.6 A2-70 A4-70	GVs4.6 FV4.6 A4-50 A4-70ⓐ	125		-	GVs4.6
	150	GVs4.6 A4-70	GVs4.6 A2-70 A4-70	GVs4.6 A4-50	150	GVs4.6	GVs4.6	GVs4.6 A4-50
					200	-	GVs4.6	GVs4.6

ⓐ on request

### Load bearing capacities for HALFEN Bolts ⓐ

Thread $\varnothing$	Load capacities for HALFEN Bolts				Recommended load bearing capacities per HALFEN Bolt in channel longitudinal direction			Recommended torques				
		F [kN]				F <sub>x</sub> [kN] ⓑ			T <sub>inst</sub> [Nm]			
		HS				HS			HS			
38/17		4.6	8.8	A2-50 A4-50	A2-70 A4-70	4.6	8.8	A2-50; A4-50 A2-70; A4-70	4.6	8.8	A2-50 A4-50	A2-70 A4-70
	F <sub>Rd</sub>	8.3	18.6	7.3	15.6	0.42	1.54	0.42	15	40	15	30
M10	allow. F	5.9	13.3	5.2	11.2	0.3	1.1	0.3				
	F <sub>Rd</sub>	12.1	27.0	10.6	22.7	0.7	2.2	0.7	25	70	25	50
M12	allow. F	8.6	19.3	7.6	16.2	0.5	1.6	0.5				
	F <sub>Rd</sub>	22.6	50.2	19.8	42.2	1.3	4.2	1.26	65	180	60	130
M16	allow. F	16.1	35.9	14.1	30.2	0.9	3.0	0.9				

ⓐ Note: do not exceed the max. channel load bearing capacity!

ⓑ Load capability through friction

### Locking plates

#### GWP 38/17

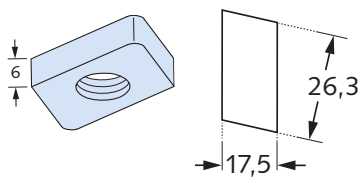

GWP 38/17 available locking plates				
GV	A4	a [mm]	b [mm]	d [mm]
M6	M6	33.5	17.5	6
M8	M8			
M10	M10			
M12	M12			

#### Load capacities GWP 38/17

Thread	Load capacity [kN]	
	F <sub>Rd</sub>	allow. F
M6	F <sub>Rd</sub>	3.1
	allow. F	2.2
M8	F <sub>Rd</sub>	5.6
	allow. F	4.0
M10	F <sub>Rd</sub>	8.0
	allow. F	5.7
M12	F <sub>Rd</sub>	8.0
	allow. F	5.7

# HALFEN INDUSTRIAL TECHNOLOGY

## Framing channels – Light duty system

### Framing channels HM 28/28 and HL 28/28

HM 28/28 – HL 28/28 cold-rolled

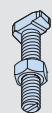

Suitable HALFEN Bolts  
HS 28/15 → see page 51

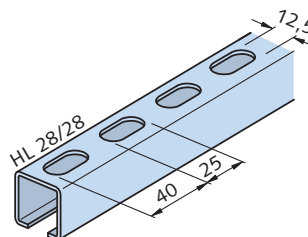
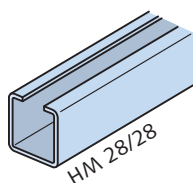
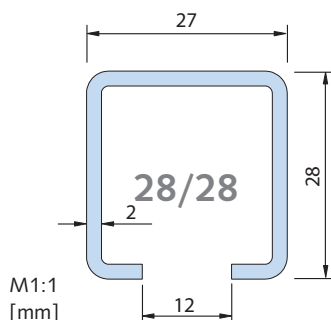

Dimensions and cross section properties								Load capacities					
		Length	Weight	Cross section area	Moment of inertia		Section modulus		Max. point-load bearing capacity		Bending load capacity at span L		
		[mm]	[kg/m]	[cm <sup>2</sup> ]	$I_y$	$I_z$	$W_y$	$W_z$	$F_z$ ①	$\leq e_w$	F [kN]		
Material	Order no.				[cm <sup>4</sup> ]	[cm <sup>4</sup> ]	[cm <sup>3</sup> ]	[cm <sup>3</sup> ]	[kN]	[cm]	0.5 m	1.0 m	1.5 m
HM 28/28	0280.	6000	1.36	1.73	1.70	2.01	1.08	1.49	4.2	31.0	F <sub>Rd</sub>		
WB	050-00001										2.7	1.3	0.7
SV	050-00003										allow. F		
FV	050-00002										1.9	0.9	0.5
A4	050-00004								3.0				
HL 28/28	0281.	6000	1.22	1.48	1.33	1.98	0.95	1.47	4.2	25.5	F <sub>Rd</sub>		
WB	060-00001										2.10	1.12	0.56
SV	060-00003										allow. F		
FV	060-00002										1.5	0.8	0.4
A4	060-00004								3.0				

① F<sub>z</sub> = max. load bearing capacity of the channel lips

### Accessories

HPE 28/28 Channel end cap  
→ see page 55

SDM - 28/6 Rubber vibration absorber  
→ see MT-FFC catalogue

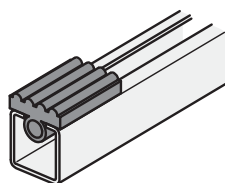
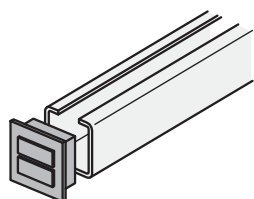

### Further design properties

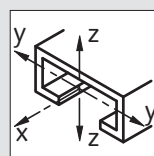

Cross section data  
→ pages 64, 66

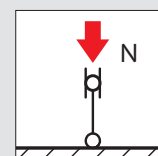

Flexural buckling  
→ page 73

# HALFEN INDUSTRIAL TECHNOLOGY

## Framing channels – Light duty system

### Framing channel HM 28/15 and HL 28/15

HM 28/15 – HL 28/15 cold-rolled

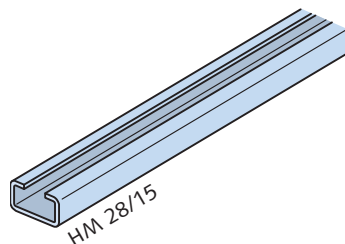
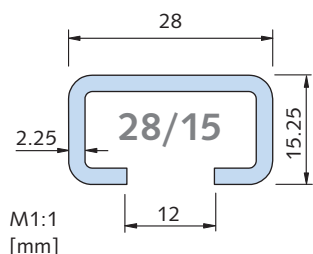

Suitable HALFEN Bolts  
HS 28/15 → see page 51

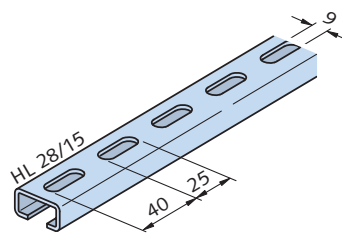

Dimensions and cross section properties									Load capacities						
Material	Order no.	Length [mm]	Weight G [kg/m]	Cross section area A [cm <sup>2</sup> ]	Moment of inertia		Section modulus		Max. point-load bearing capacity		Bending load capacity at span L				
					$I_y$ [cm <sup>4</sup> ]	$I_z$ [cm <sup>4</sup> ]	$W_y$ [cm <sup>3</sup> ]	$W_z$ [cm <sup>3</sup> ]	$F_z$ ① [kN]	$\leq e_w$ [cm]	F [kN]				
											0.5 m			1.0 m	1.5 m
HM 28/15	0280.	6070	1.09	1.39	0.41	1.45	0.46	1.03		$F_z$	$\leq e_w$	$F_{Rd}$			
WB	010-00001											5.5	1.15	0.38	0.17
FV	010-00002											allow. $F_z$	allow. F		
A2 ②	010-00004											3.9	0.82	0.27	0.12
A4 ②	010-00003														
HL 28/15	0281.	6070	0.86	1.16	0.32	1.35	0.40	0.98		$F_z$	$\leq e_w$	$F_{Rd}$			
WB	080-00001											5.5	0.98	0.31	0.14
FV	080-00004											allow. $F_z$	allow. F		
A2 ②	080-00002											3.9	0.7	0.22	0.10
A4	080-00003														

①  $F_z$  = max. load bearing capacity of the channel lips

② Stainless steel A2 on request; Note: high corrosion resistant stainless steel HCR for HM 28/15 on request

### Accessories

HPE 28/15 Channel end cap  
→ see page 55

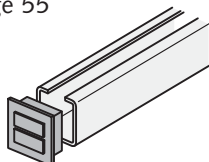

SDM - 28/6 Rubber vibration absorber  
→ see MT-FFC catalogue

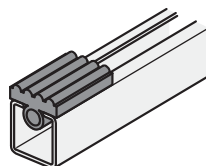

SIC 28/15 Locking washer  
→ see page 58

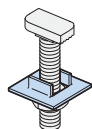

### Further design properties

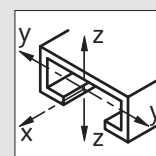

Cross section data  
→ pages 64, 66

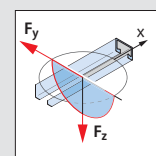

Point-load capacities  
→ page 70

# HALFEN INDUSTRIAL TECHNOLOGY

## Framing channels – Light duty system

### Framing channel HM 315 (C30)

HM 315 (C30) cold-rolled

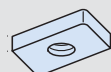

Suitable locking plates  
GWP 28/15 → see page 51

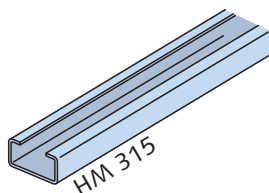
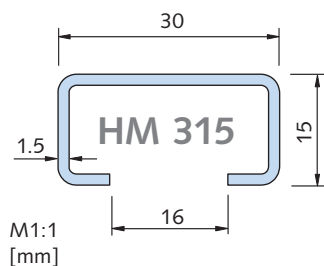

Dimensions and cross section properties									Load capacities				
Material	Order no.	Length [mm]	Weight G [kg/m]	Cross section area A [cm <sup>2</sup> ]	Moment of inertia		Section modulus		Max. point-load bearing capacity		Bending load capacity at span L		
					$I_y$ [cm <sup>4</sup> ]	$I_z$ [cm <sup>4</sup> ]	$W_y$ [cm <sup>3</sup> ]	$W_z$ [cm <sup>3</sup> ]	$F_z$ ① [kN]	$\leq e_w$ [cm]	F [kN]		
HM 315	0280.										0.5 m	1.0 m	1.5 m
WB	060-00001	6000	0.77	0.97	0.30	1.26	0.32	0.84	$F_{z,Rd}$	17.7	$F_{Rd}$		
									2.32		0.81	0.28	0.13
FV	060-00002								allow. $F_z$		allow. F		
									1.66		0.58	0.20	0.09

①  $F_z$  = max. load bearing capacity of the channel lips

### Accessories

SIC 28/15 Locking plate  
→ see page 58

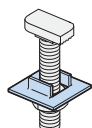

### Further design properties

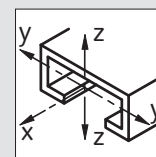

Cross section data  
→ page 64

# HALFEN INDUSTRIAL TECHNOLOGY

## Framing channels – Light duty system

### HALFEN Bolts HS 28/15

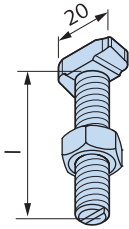

**HS 28/15**  
HALFEN Bolts  
incl. nut

Not for HM 315



**On request**  
HCR High corrosion resistant  
stainless steel

#### HS 28/15 available bolts

Length l [mm]	M6	M8	M10	M12	Length l [mm]	M6	M8	M10	M12
15	GVs4.6	GVs4.6	GVs4.6	-	50	-	GVs4.6	GVs4.6	GVs4.6
20	GVs4.6	GVs4.6 GVs8.8 A2-70 A4-70	GVs4.6 FV4.6 A2-70 A4-70	-		GVs4.6	GVs4.6 GVs8.8 A4-70	GVs4.6	-
	25	GVs4.6	GVs4.6 A2-70	GVs4.6 A2-70 A4-70	-	80	-	GVs4.6	GVs4.6
30		GVs4.6	GVs4.6 A2-70 A4-70	GVs4.6 FV4.6 A2-70 A4-70	GVs4.6	100	-	GVs4.6	GVs4.6
	35	-	-	-	GVs4.6	125	-	-	GVs4.6
40		GVs4.6	GVs4.6	GVs4.6 FV8.8 A2-70 A4-70	-	150	-	-	GVs4.6
					200	-	-	GVs4.6	
								A4-50	-

① on request

#### Load bearing capacities for HALFEN Bolts ①

Thread $\varnothing$	Load capacities for HALFEN Bolts				Recommended load bearing capacity per HALFEN Bolt in channel longitudinal direction		Recommended torque				
	$F_y$	$F_z$	$F$ [kN]		$F_x$ [kN] ②		$T_{inst}$ [Nm]				
28/15	HS				HS		HS				
	4.6	8.8	A2-50 A4-50	A2-70 A4-70	4.6; 8.8	A2-50; A4-50; A2-70; A4-70	4.6	8.8	A2-50 A4-50	A2-70 A4-70	
M6	$F_{Rd}$	2.9	6.4	2.5	5.4	0.14	0.14	3	-	3	-
	allow. F	2.1	4.6	1.8	3.8	0.1	0.1				
M8	$F_{Rd}$	5.3	11.7	4.6	9.9	0.28	0.28	8	20	8	15
	allow. F	3.8	8.3	3.3	7.1	0.2	0.2				
M10	$F_{Rd}$	8.3	18.6	7.3	15.6	0.42	0.42	15	40	15	30
	allow. F	5.9	13.3	5.2	11.2	0.3	0.3				
M12	$F_{Rd}$	12.1	27.0	10.6	22.7	0.7	0.7	25	70	25	50
	allow. F	8.6	19.3	7.6	16.2	0.5	0.5				

① Note: do not exceed the max. channel load bearing capacity

② Load capability through friction

#### Locking plates

##### GWP 28/15

for profiles 28/15 and HM 315 (C30)

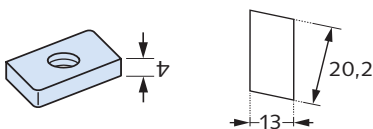

##### Assembly notes:

**M6 and M8:** insert the locking plate at an angle through the channel slot!

**M10:** insert the locking plate first, then screw in the bolt!

##### GWP 28/15 available locking plates

GV	A4	a [mm]	b [mm]	d [mm]
M5	-			
M6	M6	20.2	13.0	4
M8	M8			
M10	M10	18.6	17.0	5

##### GWP 28/15 Load capacities

Thread	$F_z$ [kN]	
	$F_{Rd}$	allow. F
M5	$F_{Rd}$	2.1
	allow. F	1.5
M6	$F_{Rd}$	2.7
	allow. F	1.9
M8	$F_{Rd}$	3.9
	allow. F	2.8
M10	$F_{Rd}$	4.2
	allow. F	3.0

# HALFEN INDUSTRIAL TECHNOLOGY

## Framing channels – Light duty system

### Framing channel HM 20/12 and HL 20/12

HM 20/12 – HL 20/12 cold-rolled



Suitable HALFEN Bolt  
HS 20/12 → see page 53

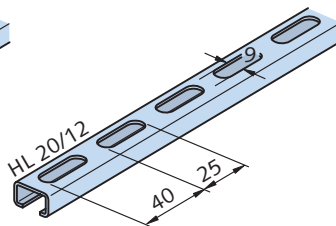
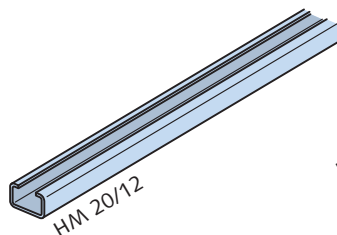
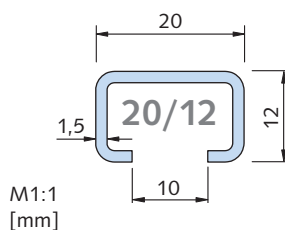

Dimensions and cross section properties									Load capacities								
Material	Order no.	Length [mm]	Weight G [kg/m]	Cross section area A [cm <sup>2</sup> ]	Moment of inertia		Section modulus		Max. point-load bearing capacity		Bending load capacity at span L						
					$I_y$ [cm <sup>4</sup> ]	$I_z$ [cm <sup>4</sup> ]	$W_y$ [cm <sup>3</sup> ]	$W_z$ [cm <sup>3</sup> ]	$F_z$ ① [kN]	$\leq e_w$ [cm]	F [kN]						
HM 20/12	0280.	6000	0.52	0.66	0.12	0.36	0.16	0.36	$F_{z,Rd}$	5.8	$F_{Rd}$						
WB	030-00001								3.14		0.42	0.11	0.06				
FV	030-00003								allow. $F_z$		allow. F						
A2	030-00002								2.24		0.30	0.08	0.04				
HL 20/12	0281.	6000	0.45	0.53	0.09	0.35	0.14	0.36	$F_{z,Rd}$	4.6	$F_{Rd}$						
WB	090-00001								3.14		0.32	0.08	0.04				
FV	090-00002								allow. $F_z$		allow. F						
A2	090-00003								2.24		0.23	0.06	0.03				

①  $F_z$  = max. load bearing capacity of the channel lips

### Accessories

SIC 20/12 Locking washer  
→ see page 58

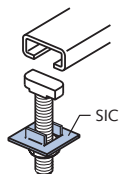

### Further design properties

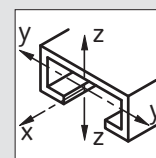

Cross section data  
→ pages 64, 66

# HALFEN INDUSTRIAL TECHNOLOGY

## Framing channels – Light duty system

### HALFEN Bolts HS 20/12

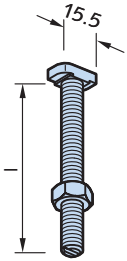

**HS 20/12**  
HALFEN Bolts  
incl. nut

### HS 20/12 available bolts

Length l [mm]	HS 20/12 available bolts		Length l [mm]	HS 20/12 available bolts	
	M6	M8		M6	M8
15	-	GVs4.6	40	GVs4.6	GVs4.6
20	GVs4.6	GVs4.6 A2-70	50	-	GVs4.6 A2-70 ①
25	-	GVs4.6	60	-	GVs4.6
30	GVs4.6	GVs4.6 A2-70	80	-	GVs4.6

① on request

### Load bearing capacities for HALFEN Bolts ①

Thread $\varnothing$	Load capacities for HALFEN Bolts		Recommended load capacity per HALFEN Bolt in channel longitudinal direction		Recommended torque		
	$F_y$ $F_z$	F [kN]	$F_x$	$F_z$	$T_{inst}$ [Nm]		
20/12	HS		HS		HS		
		4.6	A2-70	4.6	A2-70	4.6	A2-70
M6	$F_{Rd}$	2.9	5.4	0.14	0.14	3	-
	allow. F	2.1	3.8	0.1	0.1		
M8	$F_{Rd}$	5.3	9.9	0.28	0.28	8	8
	allow. F	3.8	7.1	0.2	0.2		

① Note: do not exceed the max. channel load bearing capacity

② Load capability through friction

### Locking plates

#### Locking plate GWP 20/12

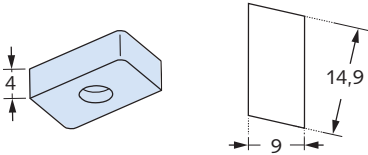

#### GWP 20/12 available locking plates

GV Thread	Thread	a [mm]	b [mm]	d [mm]
M5	A4 Thread	14.5	9	4
M5	M5			
M6	M6			

#### Load capacities for GWP 20/12

Thread	$F_z$ [kN]	
	$F_{Rd}$	allow. F
M5	$F_{Rd}$	2.1
	allow. F	1.5
M6	$F_{Rd}$	2.7
	allow. F	1.9

# ACCESSORIES /FRAMING CHANNELS

## The benefits at a glance

We provide a wide selection of accessories to complement the HALFEN range of framing channels. We can provide everything you need for your project; all from a single source.



Cold-rolled HALFEN HM/HZM Framing channels

### Fast and economical

- Complete freedom in positioning and dimensioning the bolt connections
- Fast installation and adjustment of all components and connected equipment
- Dirt-free and low-noise on-site modifications or upgrades
- Clever modular system, numerous accessory components available
- No more welding in hazardous environments
- Corrosion protection of system components isn't damaged by bolting

HALFEN Framing channels used with the appropriate accessories – i.e. HALFEN Bolts, locking plates – provide all the advantages for adaptable bolt connections and framing systems.



Hot-rolled HALFEN HM/HZM Framing channels

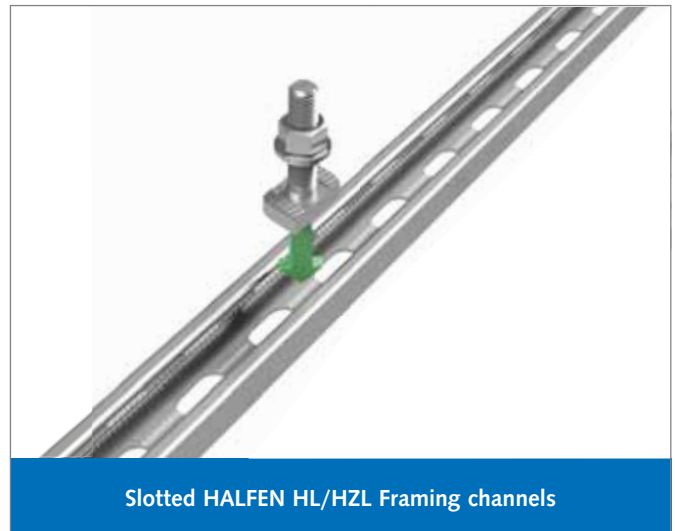

Slotted HALFEN HL/HZL Framing channels

Our wide range of accessories for HALFEN Framing channels include bolts and matching nuts in various sizes and finishes.

A wide range of accessories is also available for our slotted framing channels. → See pages 55, 58, 59.



Channel end caps

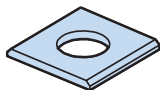

Washers

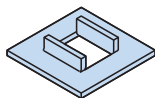

Locking washers



Nuts

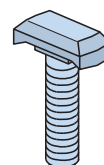

T-bolts



Ring nuts



# HALFEN INDUSTRIAL TECHNOLOGY

## HPE Channel end caps

HPE Channel end caps (plastic)



Type **HPE 63/63**  
Colour: blue

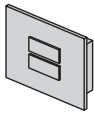

Type **HPE**  
Colour: black

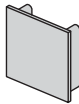

Type **HPE 41/41**  
Type **HPE 41/22**  
Colour: black

Product range		
Description	Order no. 0318.000-	Suitable for channel
HPE 63/63	00010	63/63
HPE 52/34	00001	52/34
HPE 50/40	00002	50/40
HPE 41/41	00003	41/41
HPE 41/22	00004	41/22
HPE 36/36	00005	36/36
HPE 28/28	00006	28/28
HPE 28/15	00011	28/15

Assembly diagram:

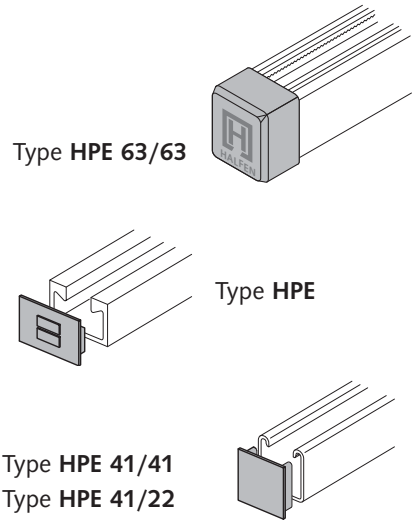

## PA Channel cover

The PA Channel cover is used to protect the channel slot against dirt etc.

### Type overview

Type	PA 41	PA 22	PA 18 H
	Suitable for profiles: 50/40, 50/30, 486, all 41/... Profiles	Suitable for profile 52/34	Suitable for profiles 36/36, 38/17
Quality: hard PVC (KS)	 white	 medium grey	 medium grey
Quality: steel sendzimir zinc plated (SV)			

Assembly diagram:

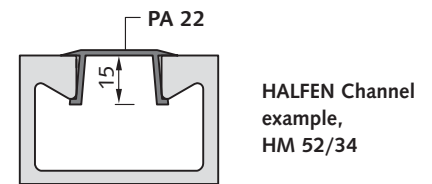

Order numbers				
Type	Length [mm]	Order no. 0321.000-		
PA - 41 - KS	- 3000	00002		
PA - 41 - SV	- 3000	00001		
PA - 22 - KS	- 3000	00003		
PA - 18H - KS	- 3000	00004		

# HALFEN INDUSTRIAL TECHNOLOGY

## Available products – Overview of HALFEN Bolts

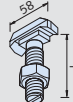
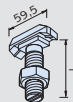
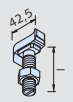
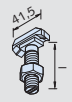
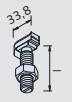
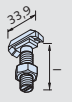
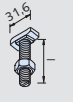
For channel	HM 72/48				HM/HL 55/42, 52/34, 50/30, 49/30, 50/40, 50/40, 486				HM 52/34 HM 50/30		HM 40/22, HM 40/25, HM 422			HM 40/22	HM 36/36, HL 36/36, HM 38/17			
	HS 72/48				HSR 72/48	HS 50/30 ① ②				HSR 50/30		HS 40/22 ②			HSR 40/22	HS 38/17 ①		
Ø																		
l [mm]	M20	M24	M27	M30	M20	M10	M12	M16	M20	M16	M20	M10	M12	M16	M16	M10	M12	M16
15																		
20												FV4.6				GVs4.6	GVs4.6	
25																		
30						FV8.8	FV4.6					FV4.6	FV4.6			GVs4.6	GVs4.6	GVs4.6
35							A4-70					A4-70	A4-50	A4-50		A4-70	A4-70	A4-50
40						FV8.8	FV4.6	FV4.6		FV8.8		FV4.6	FV4.6	FV4.6	GVs8.8	GVs4.6	GVs4.6	GVs4.6
45							FV8.8	FV8.8				FV8.8	FV8.8	FV8.8				
50	FV4.6	FV4.6				FV8.8	FV4.6	FV4.6				FV4.6	FV4.6	FV4.6		GVs4.6	GVs4.6	GVs4.6
55		A4-50					A4-70	A4-70				A4-70	A4-50	A4-70		A4-70	A4-70	A4-70
60	FV8.8						FV4.6	FV4.6		FV8.8	GVs8.8	FV4.6	FV4.6	FV4.6	FV8.8	GVs4.6	GVs4.6	GVs4.6
63							FV8.8	FV8.8				FV8.8	FV8.8	FV8.8				
65																		
70							FV8.8										FV8.8	
75	FV4.6	FV4.6	FV4.6	FV4.6	FV8.8						GVs8.8							
80							FV4.6	FV4.6	FV4.6	FV8.8		FV4.6	FV4.6	FV4.6		GVs4.6	GVs4.6	GVs4.6
100	FV4.6	FV4.6	FV8.8	FV4.6			FV4.6	FV4.6	FV4.6	FV8.8		FV4.6	FV4.6	FV4.6		GVs4.6	GVs4.6	GVs4.6
100 T																		
125							FV4.6	FV4.6	FV4.6			FV4.6	FV4.6	FV4.6			GVs4.6	GVs4.6
150	FV4.6	FV4.6		FV4.6			GVs4.6	FV4.6	FV8.8				GVs4.6	FV4.6		GVs4.6	GVs4.6	GVs4.6
175		GVs8.8						A4-50	A4-50									A4-50
200	FV4.6	FV4.6		FV4.6			GVs4.6	GVs4.6	GVs4.6					GVs4.6			GVs4.6	GVs4.6
250																		
300																		

T = with partial thread; ZL = zinc flake coated

① High corrosion resistant stainless steel HALFEN Bolts, HCR on request

# HALFEN INDUSTRIAL TECHNOLOGY

## Available products – Overview of HALFEN Bolts

	HM/HL 28/28, HM/HL 28/15				HM 20/12, HL 20/12		HM/HL/HZM/HZL 41/41, 41/22, HM/HL 41/62, HM/HL 41/83					HZL 63/63 alle 41/...		HZM 64/44		HZM 53/34		HZM 41/27, HZM 38/23		HZM 29/20						
	HS 28/15				HS 20/12		HS 41/41					HZS 41/41					HZS 41/22		HZS 64/44		HZS 53/34		HZS 38/23		HZS 29/20	
	M6	M8	M10	M12	M6	M8	M10	M12	M6	M8	M10	M12	M16	M12	M16	M20	M24	M16	M20	M12	M16	M12				
	GVs4.6	GVs4.6	GVs4.6		GVs4.6	GVs4.6																				
	GVs4.6	GVs4.6	GVs4.6		GVs4.6	GVs4.6																				
		GVs8.8	FV4.6			A2-70																				
		A2-70	A2-70			A4-70																				
		A4-70	A4-70																							
		A2-70	A2-70			A4-70																				
		A4-70	A4-70						ZL	ZL	ZL	ZL									GVs8.8	GVs8.8	GVs8.8			
				GVs4.6			FV4.6	FV4.6																		
							A4-70	A4-70						FV8.8	A4-50	A4-50										

② HS 40/22 and HS 50/30 bolts in grade GVs 4.6 and GVs 8.8 will be phased out in 2021 and will be replaced by grade FV 4.6 and FV 8.8 bolts (other GVs bolts listed in the bolt overview tables remain available).

# HALFEN INDUSTRIAL TECHNOLOGY

## Nuts and washers

1 FRAMING CHANNELS  
2 HEAVY DUTY SYSTEM  
3 MEDIUM DUTY SYSTEM  
4 LIGHT DUTY SYSTEM  
5 ACCESSORIES  
6 STATICS  
7 MECHANICAL ENGINEERING

**MU**  
Hexagonal nuts  
EN ISO 4032/  
DIN 934



GV galvanized FK 8 thread	A4 stainless steel Bolt	S/m DIN [mm]	S/m ISO [mm]
M6	M6	10/5	10/5.2
M8	M8	13/6.5	13/6.8
M10	M10	17/8	16/ 8.4
M12	M12	19/10	18/10.8
M16	M16	24/13	24/14.8
M20	M20	30/16	30/18
M24	-	36/19	36/21.5
FV hot-dip galvanized thread	A2 stainless steel Bolt	S/m DIN [mm]	S/m ISO [mm]
M6	-	10/5	10/5.2
M8	M8	13/6.5	13/6.8
M10	M10	17/8	16/8.4
M12	M12	19/10	18/10.8
M16	M16	24/13	24/14.8

**VUS**  
Square washers

FV Hot-dip galvanized Bolt size	A4 Stainless steel Bolt size	a × b × d [mm]
M10	M10	40 × 40 × 5
M12	M12	40 × 40 × 5
M16	M16	40 × 40 × 5

**VUS 40/25**  
for profile  
40/25;  
HZA  
41/22

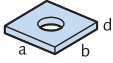

**VUS 49/30**  
for profile  
54/33,  
49/30

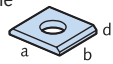

**VUS 52/34**  
for profile  
52/34,  
50/30

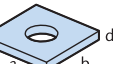

**VUS 72/49**  
for profile  
72/48,  
72/49



**VUS 41/41**  
for all  
41/..  
profiles

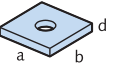

M10	M10	37 × 37 × 5
M12	M12	37 × 37 × 5
M16	M16	37 × 37 × 5
M20	M20	37 × 37 × 5

M16	M16	50 × 50 × 6
M20	M20	50 × 50 × 6

M20	M20	54 × 54 × 6
M24	M24	54 × 54 × 6
M27	M27	54 × 54 × 6
M30	M30	54 × 54 × 6

M6	M6	40 × 40 × 6
M10	M10	40 × 40 × 6
M12	M12	40 × 40 × 6

Ordering example: **VUS 52/34 - FV - M20**

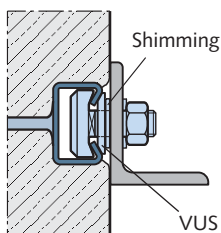

**Application VUS:**  
for shimming non-flush  
installation of HALFEN  
Anchor channels or for  
stand-off installations  
→ see page 69.

**US**  
Washers  
DIN EN  
ISO 7093/  
DIN 9021;  
DIN EN ISO  
7094

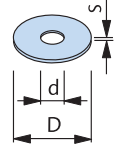

DIN/ ISO	GV galvanized, bolt	A4 stainless steel bolt	D [mm]	d [mm]	s [mm]
7094	M6	-	22	6.6	2
9021	M8	M8	24	8.4	2
9021	M10	M10	30	10.5	2.5
7094	M12	-	45	13.5	4
9021	M12	M12	37	13	3
9021	M16	M16	50	17	3
7094	M20	-	72	22	6
	FV hot-dip galv. bolt		D [mm]	d [mm]	s [mm]
9021	M10	-	30	10.5	2.5
9021	M12	-	37	13	3
9021	M16	-	50	17	3

Ordering example: **US - M12 - GV - DIN 9021**

**US**  
Washers  
DIN EN  
ISO 7089/  
DIN 125

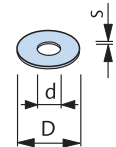

GV galvanized bolt	A4 Stainless steel bolt	D [mm]	d [mm]	s [mm]
M6	M6	12	6.4	1.6
M8	M8	16	8.4	1.6
M10	M10	21	10.5	2
M12	M12	24	13	2.5
M16	M16	30	17	3
M20	M20	37	21	3
M24	-	44	25	4
FV Hot-dip galvanized	A2 Stainless steel bolt	D [mm]	d [mm]	s [mm]
-	M8	17	8.4	1.6
M10	M10	21	10.5	2
M12	M12	24	13	2.5
M16	M16	30	17	3
M20	-	37	21	3
M27	-	50	28	4

Ordering example: **US - M12 - GV - DIN 125**

**SIC**  
Locking  
washer

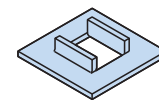

GV galvanized	A4 Stainless steel A4	Suitable for HALFEN bolts Type	Dimensions
SIC - 50/30 - GV	SIC - 50/30 - A4	50/30	M16, M20
SIC - 40/22 - GV	SIC - 40/22 - A4	38/17 40/22	M16
SIC - 38/23 - GV	-	38/23	M16
SIC - 29/20 - GV	-	29/20	M12
SIC - 38/17 - GV	SIC - 38/17 - A4	38/17 40/22	M12, M10
SIC - 28/15 - GV	SIC - 28/15 - A4	28/15	M8, M10
SIC - 20/12 - GV	SIC - 20/12 - A4	20/12	M8

Ordering example: **SIC - 38/17 - GV**

**Assembly:**

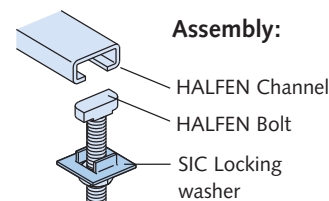

**Application SIC:**

to secure and prevent  
HALFEN Bolts  
back-turning  
during assembly.

# HALFEN INDUSTRIAL TECHNOLOGY

## Threaded rods, Hexagonal head bolts, Coupler sleeves, Ring nuts

### GWS

Threaded rods  
DIN 976-1

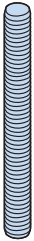

GV	A4	Length	F <sub>Rd</sub>	allow. F
Galvanized F.k. 4.6 Thread	Stainless steel A4 Thread	[mm]	① [kN]	[kN]
M6	M6	1000	3.1	2.2
M8	M8	1000	5.6	4.0
M10	M10	1000	9.0	6.4
M12	M12	1000	13.0	9.3
M16	M16	1000	24.2	17.3
M20	M20	1000	37.8	27.0
M24	-	1000	54.3	38.8

Ordering example: **GWS - M12 × 1000 - GV**

### VBM

Coupler sleeves,  
round

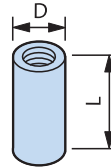

GV	A4	D	L	F <sub>Rd</sub>	allow. F
Galvanized Thread	Stainless steel Thread	[mm]	[mm]	① [kN]	[kN]
M6	M6	10/10	15	3.1	2.2
M8	M8	12/14	20	5.6	4.0
M10	M10	13/16	25	9.0	6.4
M12	M12	16/20	30	13.0	9.3
M16	M16	21/25	40	24.2	17.3
M20	M20	26/32	50	37.8	27.0

Ordering example: **VBM - A4 - M16**

### HSK

Hexagonal head  
bolts  
EN ISO 4017/  
DIN 933  
(without nut)

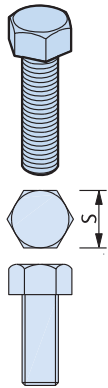

Hex bolts are used  
in combination with  
HALFEN Locking  
plates

GV 8.8	A4	S	S
Galvanized FK 8.8 Dimensions	Stainless steel Dimensions	DIN [mm]	EN ISO [mm]
M 6 × 12	-	10	10
M 6 × 25	-	13	13
M 8 × 25	M 8 × 25	13	13
M 8 × 40	-	17	16
M 10 × 20	-	17	16
M 10 × 30	M 10 × 30	17	16
M 10 × 45	M 10 × 45	17	16
M 10 × 60	-	19	18
M 10 × 70	-	19	18
M 12 × 22	-	19	18
M 12 × 25	M 12 × 25	19	18
M 12 × 30	M 12 × 30	19	18
M 12 × 40	M 12 × 40	19	18
M 12 × 50	-	24	24
M 12 × 60	M 12 × 60	24	24
M 12 × 80	M 12 × 80	24	24
M 12 × 90	-	24	24
M 16 × 40	M 16 × 40	24	24
M 16 × 60	M 16 × 60	24	24
M 16 × 90	M 16 × 90	24	24

### SKM

Hexagonal coup-  
ler sleeves with  
view holes

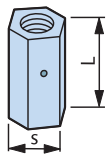

FV	A4	S	L	F <sub>Rd</sub>	allow. F
Hot-dip galvanized Thread	Stainless steel Thread	[mm]	[mm]	① [kN]	[kN]
M10	M10	13	40	9.0	6.4
M12	M12	17	40	13.0	9.3
M16	M16	22	50	24.2	17.3

Ordering example: **SKM - FV - M12**

### SPH

Turnbuckles  
with right-  
and left-hand  
thread

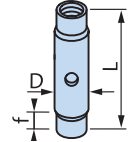

f = min. screw  
depth  
M12 ≅ 10mm  
M16 ≅ 13 mm

A4	A4	D	D
Stainless steel Thread M12 × Length L [mm]	Stainless steel Thread M16 × Length L [mm]	For M12 [mm]	For M16 [mm]
M 12 × 60	M 16 × 60	16	22
M 12 × 75	M 16 × 75	16	22
M 12 × 95	M 16 × 95	16	22
M 12 × 115	M 16 × 115	16	22
M 12 × 135	M 16 × 135	16	22
allow. F = 5 kN F <sub>Rd</sub> = 7 kN	allow. F = 10 kN F <sub>Rd</sub> = 14 kN		

Ordering example: **SPH - A4 - M12 x 75**

### HJV

Adjustment  
coupler

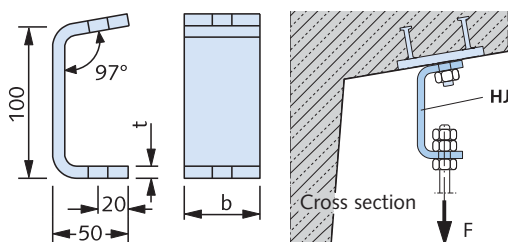
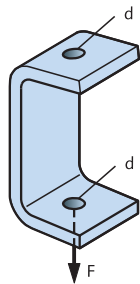

FV	A4	t	b	d	max. F <sub>Ed</sub>	allow. F
Hot-dip galvanized Type	Stainless steel Type	[mm]	[mm]	[mm]	② [kN]	[kN]
1	1	6	40	13	2.1	1.5
2	2	8	50	17	4.6	3.3
3	3	10	50	17	7.0	5

### RM

Ring nut  
DIN 582  
from 2010-09



GV	d	F <sub>Rd</sub>	allow. F
C 15E, galvanized Thread	[mm]	① [kN]	[kN]
M8	20	2.0	1.4
M10	25	3.2	2.3
M12	30	4.8	3.4
M16	35	9.8	7.0
M20	40	16.8	12.0

Ordering example: **RM - GV - M12**

- ① Recommended design value of the load capacity with a centric tensile stress
- ② Recommended design value of the load

# HALFEN ADJUSTABLE CANTILEVER

## The advantages at a glance

A revolution in tunnel pipe supports, the HALFEN Adjustable cantilever combines the established high load bearing of the medium duty system with much faster installation. It is specifically designed for tunnels or other projects with curved or inclined surfaces, and, being fully adjustable, it is not necessary to know the exact cantilever angle during planning.



### No custom cantilever brackets required, no angles to measure

- › simplified design
- › easy planning
- › lower risk of planning errors
- › quick delivery; in-stock item, therefore no lead time as for custom production

### One product for all positions dramatically reduces complexity

- › suitable for pipe clamps, shoes and cable trays
- › can be used for laid or suspended pipes
- › compensates for on-site tolerances. Remains fully adjustable



Further information on HALFEN Cantilevers is available at [www.halfen.com](http://www.halfen.com)  
Also see our Flexible Framing Connections catalogue:  
"HALFEN MT-FFC Flexible Framing Connections" Technical Product Information.





# HALFEN INDUSTRIAL TECHNOLOGY

## Cantilever brackets

### Cantilevers KON

**Flexible comprehensive support system**  
 For low load or for very high load requirements: you are guaranteed to find the most cost-efficient solution for all requirements in our range of products. The versatile bolt connections allow components to be assembled, disassembled, re-positioned or adjusted quickly and easily.

**Short assembly times**  
 The adaptability of HALFEN Cantilevers and bolts make them ideal when the sizes and positions of bolts cannot be defined during the planning stage of a project. Using our range of products avoids costly and complex adjusting, drilling or thread cutting in corrosion protected components.



Pipe supports with cantilevers brackets in a sewage treatment plant

#### Cantilever 52:

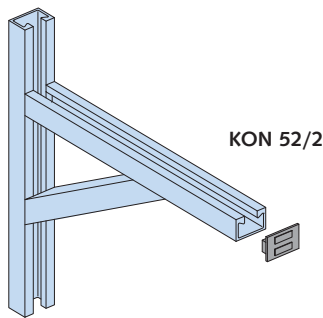

#### Cantilever 41:

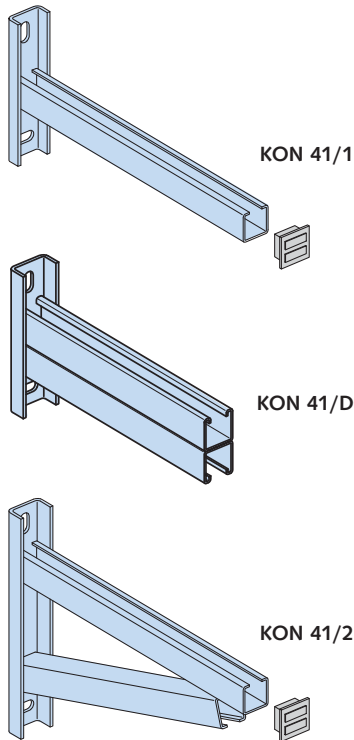

#### Cantilever 36/28:

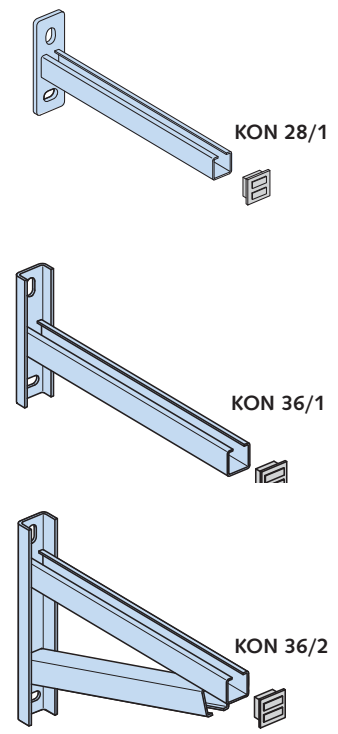





Note: Depending on the number of required brackets, custom cantilevers are available for all types

1	FRAMING CHANNELS
2	HEAVY DUTY SYSTEM
3	MEDIUM DUTY SYSTEM
4	LIGHT DUTY SYSTEM
5	ACCESSORIES
6	STATICS
7	MECHANICAL ENGINEERING

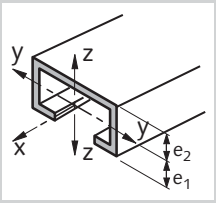
# HALFEN INDUSTRIAL TECHNOLOGY

## HALFEN Framing channels, Hot-rolled, Non-slotted – Channel specifications overview

FRAMING CHANNELS	HEAVY DUTY SYSTEM	MEDIUM DUTY SYSTEM	LIGHT DUTY SYSTEM	ACCESSORIES	STATICS	MECHANICAL ENGINEERING	Hot-rolled												
							Materials/coatings	Channel weight	Cross section area	Centroid	Moment of inertia		Elastic/plastic section modulus				Max. point-load bearing capacity ①		
								G [kg/m]	A [cm <sup>2</sup> ]	e <sub>2</sub> [cm]	I <sub>y</sub> [cm <sup>4</sup> ]	I <sub>z</sub> [cm <sup>4</sup> ]	W <sub>y,el</sub> [cm <sup>3</sup> ]	W <sub>z,el</sub> [cm <sup>3</sup> ]	W <sub>y,pl</sub> [cm <sup>3</sup> ]	W <sub>z,pl</sub> [cm <sup>3</sup> ]	allow. F <sub>z</sub> [kN]	F <sub>z,Rd</sub> [kN]	e <sub>w</sub> [cm]
	HM 72/48	WB	-	FV	-	A4	8.85	11.27	2.45	34.97	83.35	14.28	23.15	18.28	28.94	47.6	66.7	30.0	
	HM 55/42	WB	-	FV	-	-	6.76	8.61	1.99	18.75	36.29	8.49	13.32	11.73	16.69	39.7	55.6	25.0	
	HM 52/34						4.98	6.35	1.61	9.33	23.74	5.36	9.04	7.19	11.50	27.0	37.8	20.0	
	HM 50/30	WB	-	FV	-	A4	3.26	4.15	1.37	5.26	13.78	3.23	5.62	4.38	7.05	15.1	21.1	20.0	
	HM 40/22						2.12	2.70	1.05	1.99	5.77	1.59	2.92	2.17	3.68	10.3	14.4	15.0	
	HM 72/48 D ④						17.70	22.54	4.85	205.15	166.70	42.30	46.30	55.20	57.89	47.6	66.7	30.0	
	HM 55/42 D ④						13.52	17.22	4.20	105.70	72.58	25.17	26.64	34.27	33.37	39.7	55.6	25.0	
	HM 52/34 D ④	⑤	-	⑤	-	⑤	9.96	12.70	3.35	51.49	47.48	15.37	18.09	20.42	23.00	27.0	37.8	20.0	
	HM 50/30 D ④						6.52	8.27	3.00	26.56	28.14	8.85	11.49	11.52	14.27	15.1	21.1	20.0	
	HM 40/22 D ④						4.24	5.33	2.30	10.06	11.61	4.38	5.88	5.73	7.36	10.3	14.4	15.0	
	HZM 64/44	WB	-	FV	-	A4	7.15	9.10	2.10	23.83	53.94	10.36	16.85	13.66	20.86	38.1	53.3	25.0	
	HZM 53/34	WB	-	FV	-	A4	4.63	5.88	1.54	9.19	23.18	4.95	8.83	6.80	10.94	30.9	43.3	20.0	
	HZM 41/27	WB	-	FV	-	-	3.38	4.31	1.19	3.90	9.49	2.57	4.75	3.74	5.98	17.8	25.0	20.0	
	HZM 38/23	WB	-	FV	-	A4	2.43	3.10	0.97	2.11	6.17	1.59	3.25	2.31	4.06	12.8	18.0	20.0	
	HZM 29/20	WB	-	FV	-	-	1.55	1.99	0.88	1.02	2.42	0.91	1.67	1.31	2.06	8.0	11.2	15.0	
	HZM 64/44 D ④						14.3	18.21	4.40	127.94	107.87	29.08	33.71	38.23	41.72	38.1	53.3	25.0	
	HZM 53/34 D ④						9.26	11.75	3.40	46.38	46.36	13.64	17.66	18.14	21.89	30.9	43.3	20.0	
	HZM 41/27 D ④	⑤	-	⑤	-	⑤	6.76	8.62	2.70	19.91	18.98	7.37	9.49	10.22	11.96	17.8	25.0	20.0	
	HZM 38/23 D ④						4.86	6.19	2.30	10.04	12.35	4.36	6.50	6.00	8.13	12.8	18.0	20.0	
	HZM 29/20 D ④						3.10	3.97	2.00	5.12	4.84	2.56	3.34	3.49	4.11	8.0	11.2	15.0	

① Minimum distance  $a_e$  between the channel end and the load point (HALFEN Bolt, locking plate)  $a_e \geq 40$  mm, The load point must not be located past the outer fixing positions.

② Do not exceed the bolt load capacity or the max. channel load bearing capacity.

③ For maximum point-load capacity:  
 $F_z = \text{max. load bearing capacity of the channel lips.}$

④ Take constructive measures to prevent failure caused by bulging, bending and buckling.

⑤ On request.



# HALFEN INDUSTRIAL TECHNOLOGY

## HALFEN Framing channels, Hot-rolled, Non-slotted – Channel specifications overview

Material: steel, type WB, FV E= 210.000 N/mm<sup>2</sup>

Bending load capacity at span L (single span element) ②

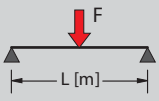
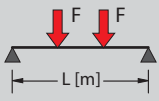
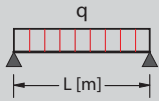
F [kN]		F [kN]		q [kN/m]	
allow. F <sub>z</sub>	F <sub>Rd</sub>	allow. F <sub>z</sub>	F <sub>Rd</sub>	allow. F <sub>z</sub>	F <sub>Rd</sub>
0.50 m		1.00 m		1.50 m	
22.3	31.2	11.2	15.6	7.4	10.4
16.8	23.5	8.4	11.7	5.6	7.8
8.8	12.3	4.4	6.1	2.8	3.9
5.4	7.5	2.7	3.7	1.6	2.2
2.6	3.7	1.3	1.9	0.6	0.8
0.50 m		1.00 m		1.50 m	
16.7	23.4	8.4	11.7	5.6	7.8
12.6	17.6	6.3	8.8	3.3	4.6
6.6	9.2	3.3	4.6	1.6	2.3
4.0	5.6	2.0	2.8	0.9	1.3
2.0	2.8	0.8	1.1	0.3	0.5
0.50 m		1.00 m		1.50 m	
89.3	125.0	22.3	31.2	9.9	13.9
67.0	93.8	16.8	23.5	6.0	8.4
35.1	49.1	8.8	12.3	3.0	4.2
21.4	30.0	5.4	7.5	1.7	2.3
10.6	14.8	2.1	3.0	0.6	0.9
1.00 m		2.00 m		3.00 m	
33.7	47.2	16.8	23.6	11.2	15.7
24.5	34.3	12.2	17.1	7.9	11.0
12.5	17.4	6.2	8.7	3.8	5.4
7.0	9.8	3.5	4.9	2.0	2.8
3.5	4.9	1.7	2.4	0.8	1.1
1.00 m		2.00 m		3.00 m	
25.3	35.4	12.6	17.7	8.4	11.8
18.4	25.7	9.2	12.8	4.6	6.5
9.3	13.1	4.7	6.5	2.3	3.2
5.3	7.4	2.6	3.7	1.2	1.6
2.6	3.7	1.0	1.4	0.4	0.6
0.50 m		1.00 m		1.50 m	
24.8	34.8	12.4	17.4	7.1	10.0
12.4	17.3	6.2	8.6	2.7	3.8
6.8	9.5	2.6	3.7	1.2	1.6
4.2	5.9	1.4	2.0	0.6	0.9
2.4	3.3	0.7	1.0	0.3	0.4
0.50 m		1.00 m		1.50 m	
99.4	139.1	24.8	34.8	7.6	10.6
49.4	69.2	9.9	13.8	2.9	4.1
27.2	38.1	4.2	5.9	1.2	1.7
16.8	23.5	2.3	3.2	0.7	0.9
8.8	12.3	1.1	1.5	0.3	0.5
1.00 m		2.00 m		3.00 m	
34.8	48.7	17.4	24.3	9.6	13.4
16.5	23.1	7.8	10.9	3.5	4.8
9.3	13.0	3.3	4.7	1.5	2.1
5.5	7.6	1.7	2.4	0.7	1.0
3.2	4.4	0.9	1.2	0.4	0.5
1.00 m		2.00 m		3.00 m	
69.5	97.3	17.2	24.1	5.1	7.1
33.0	46.2	6.2	8.7	1.8	2.6
18.6	26.0	2.7	3.7	0.8	1.1
10.8	15.1	1.3	1.9	0.4	0.6
5.5	7.7	0.7	1.0	0.2	0.3

All load capacities are calculated using the elastic-plastic method acc. to EN 1993-1, partial safety factor  $\gamma_F = 1.4$ ; deflection  $\leq l / 150$ .  
 Determination of the allowable value  
**allow. F<sub>z</sub> = F<sub>Rd</sub> / 1.4**

**Note:** For stainless steel framing channels the bending deflection value must be verified separately using the valid (elasticity) E-modulus.

1	FRAMING CHANNELS
2	HEAVY DUTY SYSTEM
3	MEDIUM DUTY SYSTEM
4	LIGHT DUTY SYSTEM
5	ACCESSORIES
6	STATICS
7	MECHANICAL ENGINEERING

# HALFEN INDUSTRIAL TECHNOLOGY

## HALFEN Framing Channels, Cold-Rolled, Non-Slotted – Channel specifications overview

FRAMING CHANNELS	HEAVY DUTY SYSTEM	MEDIUM DUTY SYSTEM	LIGHT DUTY SYSTEM	ACCESSORIES	STATICS	MECHANICAL ENGINEERING	Cold-rolled												
							Materials/coatings	Channel weight	Cross section area	Centroid	Moment of inertia		Elastic/plastic section modulus				Max. point-load bearing capacity ①		
								G [kg/m]	A [cm <sup>2</sup> ]	e <sub>2</sub> [cm]	I <sub>y</sub> [cm <sup>4</sup> ]	I <sub>z</sub> [cm <sup>4</sup> ]	W <sub>y,el</sub> [cm <sup>3</sup> ]	W <sub>z,el</sub> [cm <sup>3</sup> ]	W <sub>y,pl</sub> [cm <sup>3</sup> ]	W <sub>z,pl</sub> [cm <sup>3</sup> ]	allow. F <sub>z</sub> [kN]	F <sub>z,Rd</sub> [kN]	e <sub>w</sub> [cm]
	HM 49/30	WB	-	FV	-	A4	2.88	3.67	1.23	4.16	13.23	2.35	5.29	3.56	6.49	4.9	6.9	46.0	
	HM 40/25	WB	-	FV	-	A4	2.09	2.66	1.02	2.05	6.09	1.39	3.05	2.11	3.75	3.8	5.3	33.0	
	HM 50/40	WB	-	FV	-	A4	3.35	4.26	1.72	8.64	15.49	3.96	6.32	5.53	7.62	5.4	7.6	63.0	
	HM 486	WB	-	FV	-	-	2.31	2.95	1.15	2.97	9.62	1.92	4.01	2.71	4.95	3.5	4.7	47.0	
	HM 422 (C40)	WB	-	FV	-	-	1.55	1.98	0.93	1.27	4.29	1.04	2.17	1.46	2.71	2.5	3.5	36.0	
	HM 41/41	WB	SV	FV	-	A4	2.67	3.40	1.82	7.47	9.44	3.24	4.57	4.57	5.37	5.6	7.8	49.0	
	HZM 41/41	WB	-	FV	-	A4	2.63	3.36	1.80	7.34	9.37	3.15	4.54	4.48	5.31	5.6	7.8	47.0	
	HM 41/22	WB	SV	FV	-	A4	1.86	2.38	0.85	1.28	5.56	1.05	2.69	1.59	3.37	5.6	7.8	15.0	
	HZM 41/22	WB	-	FV	-	A4	1.83	2.33	0.84	1.26	5.48	1.03	2.66	1.56	3.32	5.6	7.8	14.0	
	HM 41/83 ④	WB	SV	FV	-	-	4.29	5.47	3.84	43.82	17.22	9.91	8.34	13.73	9.38	5.6	7.8	148.0	
	HM 41/62 ④	WB	SV	FV	-	-	3.48	4.44	2.83	20.96	13.34	6.21	6.46	8.63	7.38	5.6	7.8	92.0	
	HM 41/41 D ④	WB	-	FV	-	A4	5.34	6.81	4.13	37.60	18.88	9.10	9.14	12.42	10.75	5.6	7.8	49.0	
	HZM 41/41 D ④	WB	-	FV	-	A4	5.27	6.71	4.13	36.45	18.73	8.83	9.07	12.09	10.63	5.6	7.8	47.0	
	HM 41/22 D ④	WB	-	FV	-	A4	3.73	4.75	2.07	6.02	11.11	2.91	5.38	4.06	6.75	5.6	7.8	15.0	
	HZM 41/22 D ④	⑤	-	FV	-	A4	3.58	4.65	2.07	5.83	10.97	2.82	5.31	3.92	6.63	5.6	7.8	14.0	
	HM 41/62 D ④	WB	-	⑤	-	A4	6.97	8.88	6.20	112.88	26.68	18.21	12.92	25.10	14.76	5.6	7.8	92.0	
	HM 36/36	WB	-	FV	-	A4	2.20	2.80	1.53	4.54	5.89	2.19	3.27	3.19	3.85	4.4	6.2	44.0	
	HM 38/17	WB	-	FV	A2	A4	1.78	2.27	0.70	0.84	4.13	0.80	2.20	1.21	2.82	4.8	6.7	11.0	
	HM 315 (C30)	WB	-	FV	-	-	0.77	0.98	0.58	0.30	1.26	0.32	0.84	0.47	1.03	1.66	2.32	17.7	
	HM 28/28	WB	SV	FV	-	A4	1.36	1.73	1.22	1.70	2.01	1.08	1.49	1.54	1.77	3.0	4.20	31.0	
	HM 28/15	WB	-	FV	A2	A4	1.09	1.39	0.64	0.41	1.45	0.46	1.03	0.67	1.31	3.90	5.50	8.2	
	HM 20/12	WB	-	FV	A2	-	0.52	0.66	0.48	0.12	0.36	0.16	0.36	0.25	0.45	2.24	3.14	5.8	

① Minimum distance  $a_e$  between the channel end and the load point (HALFEN Bolt, locking plate)  $a_e \geq 40$  mm, The load point must not be located past the outer fixing positions.

② Do not exceed the bolt load capacity or the max. channel load bearing capacity.

③ For maximum point-load capacity:  
F<sub>z</sub> = max. load bearing capacity of the channel lips.

④ Take constructive measures to prevent failure caused by bulging, tilting and buckling.

⑤ On request.

# HALFEN INDUSTRIAL TECHNOLOGY

## HALFEN Framing Channels, Cold-Rolled, Non-Slotted – Channel specifications overview

Material: steel, type WB, FV, SV E= 210.000 N/mm<sup>2</sup>

Bending load capacity at span L (single span element) ②

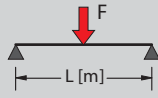

F [kN]

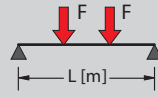

F [kN]

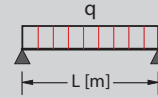

q [kN/m]

allow. F <sub>z</sub>	F <sub>Rd</sub>	allow. F <sub>z</sub>	F <sub>Rd</sub>	allow. F <sub>z</sub>	F <sub>Rd</sub>	allow. F <sub>z</sub>	F <sub>Rd</sub>	allow. F <sub>z</sub>	F <sub>Rd</sub>	allow. F <sub>z</sub>	F <sub>Rd</sub>	allow. F <sub>z</sub>	F <sub>Rd</sub>	allow. q <sub>z</sub>	q <sub>Rd</sub>	allow. q <sub>z</sub>	q <sub>Rd</sub>	allow. q <sub>z</sub>	q <sub>Rd</sub>
0.50 m		1.00 m		1.50 m		0.50 m		1.00 m		1.50 m		0.50 m		1.00 m		1.50 m			
4.3	6.1	2.2	3.0	1.2	1.7	3.3	4.6	1.6	2.3	0.7	1.0	17.4	24.3	4.3	6.1	1.3	1.9		
2.6	3.6	1.3	1.8	0.6	0.9	1.9	2.7	0.8	1.1	0.4	0.5	10.3	14.5	2.2	3.1	0.7	0.9		
6.8	9.5	3.4	4.7	2.3	3.2	5.1	7.1	2.5	3.5	1.5	2.1	27.0	37.8	6.8	9.5	2.8	3.9		
3.3	4.6	1.7	2.3	0.9	1.2	2.5	3.5	1.2	1.6	0.5	0.7	13.2	18.5	3.2	4.5	0.9	1.3		
1.8	2.5	0.9	1.2	0.4	0.5	1.3	1.9	0.5	0.7	0.2	0.3	7.1	10.0	1.4	1.9	0.4	0.6		

allow. F <sub>z</sub>	F <sub>Rd</sub>	allow. F <sub>z</sub>	F <sub>Rd</sub>	allow. F <sub>z</sub>	F <sub>Rd</sub>	allow. F <sub>z</sub>	F <sub>Rd</sub>	allow. F <sub>z</sub>	F <sub>Rd</sub>	allow. F <sub>z</sub>	F <sub>Rd</sub>	allow. F <sub>z</sub>	F <sub>Rd</sub>	allow. q <sub>z</sub>	q <sub>Rd</sub>	allow. q <sub>z</sub>	q <sub>Rd</sub>	allow. q <sub>z</sub>	q <sub>Rd</sub>
0.50 m		1.00 m		1.50 m		0.50 m		1.00 m		1.50 m		0.50 m		1.00 m		1.50 m			
5.6	7.8	2.8	3.9	1.9	2.6	4.2	5.9	2.1	2.9	1.3	1.8	22.3	31.2	5.6	7.8	2.4	3.3		
5.5	7.7	2.7	3.8	1.8	2.6	4.1	5.7	2.1	2.9	1.3	1.8	21.9	30.6	5.5	7.7	2.3	3.3		
1.9	2.7	0.9	1.2	0.4	0.5	1.5	2.0	0.5	0.7	0.2	0.3	7.8	10.9	1.4	1.9	0.4	0.6		
1.9	2.7	0.8	1.2	0.4	0.5	1.4	2.0	0.5	0.7	0.2	0.3	7.6	10.6	1.4	1.9	0.4	0.6		

allow. F <sub>z</sub>	F <sub>Rd</sub>	allow. F <sub>z</sub>	F <sub>Rd</sub>	allow. F <sub>z</sub>	F <sub>Rd</sub>	allow. F <sub>z</sub>	F <sub>Rd</sub>	allow. F <sub>z</sub>	F <sub>Rd</sub>	allow. F <sub>z</sub>	F <sub>Rd</sub>	allow. F <sub>z</sub>	F <sub>Rd</sub>	allow. q <sub>z</sub>	q <sub>Rd</sub>	allow. q <sub>z</sub>	q <sub>Rd</sub>	allow. q <sub>z</sub>	q <sub>Rd</sub>
1.00 m		2.00 m		3.00 m		1.00 m		2.00 m		3.00 m		1.00 m		2.00 m		3.00 m			
8.4	11.7	4.2	5.9	2.8	3.9	6.3	8.8	3.1	4.4	1.9	2.7	16.8	23.5	4.2	5.9	1.7	2.4		
5.3	7.4	2.6	3.7	1.6	2.2	3.9	5.5	2.0	2.8	0.9	1.3	10.5	14.7	2.6	3.7	0.8	1.2		

allow. F <sub>z</sub>	F <sub>Rd</sub>	allow. F <sub>z</sub>	F <sub>Rd</sub>	allow. F <sub>z</sub>	F <sub>Rd</sub>	allow. F <sub>z</sub>	F <sub>Rd</sub>	allow. F <sub>z</sub>	F <sub>Rd</sub>	allow. F <sub>z</sub>	F <sub>Rd</sub>	allow. F <sub>z</sub>	F <sub>Rd</sub>	allow. q <sub>z</sub>	q <sub>Rd</sub>	allow. q <sub>z</sub>	q <sub>Rd</sub>	allow. q <sub>z</sub>	q <sub>Rd</sub>
1.00 m		1.50 m		2.00 m		1.00 m		1.50 m		2.00 m		1.00 m		1.50 m		2.00 m			
7.6	10.6	5.1	7.1	3.8	5.3	5.7	8.0	3.8	5.3	2.8	4.0	15.2	21.2	6.7	9.4	3.8	5.3		
7.4	10.3	4.9	6.9	3.7	5.2	5.5	7.7	3.7	5.2	2.8	3.9	14.8	20.7	6.6	9.2	3.7	5.2		
2.5	3.5	1.7	2.3	1.0	1.4	1.9	2.6	1.1	1.5	0.6	0.8	5.0	6.9	1.9	2.7	0.8	1.1		
2.4	3.4	1.6	2.2	1.0	1.4	1.8	2.5	1.0	1.4	0.6	0.8	4.8	6.7	1.9	2.6	0.8	1.1		
15.3	21.4	10.2	14.3	7.7	10.7	11.5	16.1	7.7	10.7	5.7	8.0	30.6	42.9	13.6	19.1	7.7	10.7		

allow. F <sub>z</sub>	F <sub>Rd</sub>	allow. F <sub>z</sub>	F <sub>Rd</sub>	allow. F <sub>z</sub>	F <sub>Rd</sub>	allow. F <sub>z</sub>	F <sub>Rd</sub>	allow. F <sub>z</sub>	F <sub>Rd</sub>	allow. F <sub>z</sub>	F <sub>Rd</sub>	allow. F <sub>z</sub>	F <sub>Rd</sub>	allow. q <sub>z</sub>	q <sub>Rd</sub>	allow. q <sub>z</sub>	q <sub>Rd</sub>	allow. q <sub>z</sub>	q <sub>Rd</sub>
0.50 m		1.00 m		1.50 m		0.50 m		1.00 m		1.50 m		0.50 m		1.00 m		1.50 m			
3.9	5.5	1.9	2.7	1.3	1.8	2.9	4.1	1.5	2.0	0.8	1.1	15.6	21.8	3.9	5.5	1.4	2.0		
1.5	2.1	0.6	0.8	0.3	0.4	1.1	1.6	0.3	0.5	0.15	0.2	5.9	8.3	0.9	1.3	0.3	0.4		
0.6	0.8	0.2	0.3	0.1	0.1	0.4	0.6	0.12	0.16	0.05	0.07	2.3	3.2	0.3	0.4	0.1	0.1		
1.9	2.6	0.9	1.3	0.5	0.7	1.4	2.0	0.7	0.9	0.3	0.4	7.5	10.5	1.8	2.6	0.5	0.8		
0.8	1.2	0.3	0.4	0.12	0.17	0.6	0.9	0.16	0.2	0.07	0.1	3.3	4.6	0.4	0.6	0.13	0.2		
0.3	0.42	0.08	0.11	0.03	0.05	0.18	0.26	0.05	0.06	0.02	0.03	1.0	1.40	0.12	0.17	0.04	0.05		













All load capacities were calculated using the elastic-plastic method acc. to EN 1993-1, partial safety factor  $\gamma_F = 1.4$ ; deflection  $\leq l / 150$ .

Determination of the allowable value  
 $\text{allow. } F_z = F_{Rd} / 1.4$

**Note:** For stainless steel framing channels the bending deflection value must be verified separately using the valid (elasticity) E-modulus.

# HALFEN INDUSTRIAL TECHNOLOGY

## Framing Channels, Cold-Rolled, Slotted – Bending Load Capacities

FRAMING CHANNELS	HEAVY DUTY SYSTEM	2	Material/coating	Hot-rolled											Max. point-load bearing capacity ①		
				Channel weight	Cross section area	Centre gravity	Moment of inertia		Elastic/plastic section modulus			allow. F <sub>z</sub> [kN]	F <sub>z,Rd</sub> [kN]	e <sub>w</sub> [cm]			
							G [kg/m]	A [cm <sup>2</sup> ]	e <sub>2</sub> [cm]	I <sub>y</sub> [cm <sup>4</sup> ]	I <sub>z</sub> [cm <sup>4</sup> ]				W <sub>y,el</sub> [cm <sup>3</sup> ]	W <sub>z,el</sub> [cm <sup>3</sup> ]	W <sub>y,pl</sub> [cm <sup>3</sup> ]
	HL 50/40	WB	-	FV	-	A4	3.15	3.73	1.95	7.14	15.36	3.65	6.27	4.68	5.4	7.6	53.0
	HSL 63/63	-	-	FV	-	-	6.35	7.09	3.29	33.07	42.95	10.06	13.63	13.51	5.6	7.8	134.0
	HL 41/41	WB	SV	FV	-	A4	2.46	2.98	1.99	6.07	9.16	2.84	4.43	3.82	5.6	7.8	42.0
	HL 41/22	WB	SV	FV	-	A4	1.57	1.95	0.96	0.99	5.27	0.89	2.55	1.27	5.6	7.8	12.0
	HSL 41/41	WB	-	FV	-	A4	2.46	2.90	1.95	5.87	9.04	2.69	4.38	3.70	5.6	7.8	41.0
	HSL 41/22	WB	-	FV	-	A4	1.57	1.87	0.94	0.97	5.15	0.86	2.49	1.23	5.6	7.8	12.0
	HL 41/83 ④	WB	⑤	FV	-	-	3.93	5.02	4.07	37.07	16.93	8.85	8.20	12.03	5.6	7.8	133.0
	HL 41/62 ④	WB	⑤	FV	-	-	3.14	3.99	3.04	17.27	13.03	5.47	6.31	7.35	5.6	7.8	81.0
	HL 36/36	WB	-	FV	-	A4	2.00	2.42	1.75	3.65	5.78	1.97	3.21	2.64	4.4	6.2	36.0
	HL 28/28	WB	SV	FV	-	A4	1.22	1.48	1.41	1.33	1.98	0.95	1.47	1.25	3.0	4.2	25.5
	HL 28/15	WB	-	FV	A2	A4	0.86	1.16	0.71	0.32	1.35	0.40	0.98	0.55	3.9	5.5	7.0
	HL 20/12	WB	-	FV	A2	-	0.45	0.53	0.59	0.09	0.35	0.14	0.36	0.19	2.2	3.1	4.6

HL/HZL channel dimensions/holes and spacings				
Profile HL/HZL	D [mm]	L [mm]	A [mm]	a [mm]
50/40	18	40	60	20
63/63	14	28	250	222
41/41	14	28	50	22
41/22	14	28	50	22
41/83	14	28	50	22
41/62	14	28	50	22
36/36	15	40	60	20
28/28	12.5	25	40	15
28/15	9	25	40	15
20/12	9	25	40	15

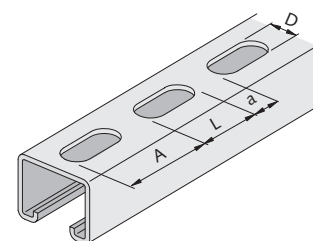

Other hole sizes and spacings on request

# HALFEN INDUSTRIAL TECHNOLOGY

## Framing Channels, Cold-Rolled, Slotted – Bending Load Capacities

Material: Steel, type WB, FV, SV E= 210.000 N/mm<sup>2</sup>

Bending load capacity at span L (single span element) ②

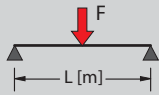

F [kN]

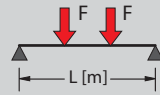

F [kN]

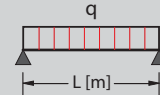

q [kN/m]

allow. F <sub>z</sub>	F <sub>Rd</sub>	allow. F <sub>z</sub>	F <sub>Rd</sub>	allow. F <sub>z</sub>	F <sub>Rd</sub>	allow. F <sub>z</sub>	F <sub>Rd</sub>	allow. F <sub>z</sub>	F <sub>Rd</sub>	allow. F <sub>z</sub>	F <sub>Rd</sub>	allow. q <sub>z</sub>	q <sub>Rd</sub>	allow. q <sub>z</sub>	q <sub>Rd</sub>	allow. q <sub>z</sub>	q <sub>Rd</sub>
0.50 m		1.00 m		1.50 m		0.50 m		1.00 m		1.50 m		0.50 m		1.00 m		1.50 m	
5.7	7.98	2.9	4.06	1.9	2.66	4.3	6.02	2.1	2.94	1.3	1.82	22.9	32.06	5.7	7.98	2.3	3.22

allow. F <sub>z</sub>	F <sub>Rd</sub>	allow. F <sub>z</sub>	F <sub>Rd</sub>	allow. F <sub>z</sub>	F <sub>Rd</sub>	allow. F <sub>z</sub>	F <sub>Rd</sub>	allow. F <sub>z</sub>	F <sub>Rd</sub>	allow. F <sub>z</sub>	F <sub>Rd</sub>	allow. q <sub>z</sub>	q <sub>Rd</sub>	allow. q <sub>z</sub>	q <sub>Rd</sub>	allow. q <sub>z</sub>	q <sub>Rd</sub>
0.50 m		1.00 m		1.50 m		0.50 m		1.00 m		1.50 m		0.50 m		1.00 m		1.50 m	
16.5	23.1	8.2	11.5	5.5	7.7	12.4	17.4	6.2	8.7	4.1	5.7	66	92.4	16.5	23.1	7.3	10.2
4.7	6.6	2.3	3.2	1.6	2.2	3.5	4.9	1.7	2.4	1.1	1.5	18.7	26.2	4.7	6.6	1.9	2.7
1.6	2.2	0.7	1.0	0.3	0.4	1.2	1.7	0.4	0.6	0.17	0.2	6.2	8.7	1.1	1.5	0.3	0.4
4.5	6.3	2.3	3.2	1.5	2.1	3.4	4.8	1.7	2.4	1	1.4	18.1	25.3	4.5	6.3	1.9	2.7
1.5	2.1	0.6	0.8	0.3	0.4	1.1	1.5	0.4	0.6	0.16	0.2	6	8.4	1	1.4	0.3	0.4

allow. F <sub>z</sub>	F <sub>Rd</sub>	allow. F <sub>z</sub>	F <sub>Rd</sub>	allow. F <sub>z</sub>	F <sub>Rd</sub>	allow. F <sub>z</sub>	F <sub>Rd</sub>	allow. F <sub>z</sub>	F <sub>Rd</sub>	allow. F <sub>z</sub>	F <sub>Rd</sub>	allow. q <sub>z</sub>	q <sub>Rd</sub>	allow. q <sub>z</sub>	q <sub>Rd</sub>	allow. q <sub>z</sub>	q <sub>Rd</sub>
1.00 m		2.00 m		3.00 m		1.00 m		2.00 m		3.00 m		1.00 m		2.00 m		3.00 m	
7.3	10.2	3.7	5.2	2.4	3.4	5.5	7.7	2.8	3.9	1.6	2.2	14.7	20.6	3.7	5.2	1.5	2.1
4.5	6.3	2.2	3.1	1.3	1.8	3.4	4.8	1.7	2.4	0.8	1.1	9	12.6	2.2	3.1	0.7	1.0

allow. F <sub>z</sub>	F <sub>Rd</sub>	allow. F <sub>z</sub>	F <sub>Rd</sub>	allow. F <sub>z</sub>	F <sub>Rd</sub>	allow. F <sub>z</sub>	F <sub>Rd</sub>	allow. F <sub>z</sub>	F <sub>Rd</sub>	allow. F <sub>z</sub>	F <sub>Rd</sub>	allow. q <sub>z</sub>	q <sub>Rd</sub>	allow. q <sub>z</sub>	q <sub>Rd</sub>	allow. q <sub>z</sub>	q <sub>Rd</sub>
0.50 m		1.00 m		1.50 m		0.50 m		1.00 m		1.50 m		0.50 m		1.00 m		1.50 m	
3.20	4.48	1.60	2.24	1.10	1.54	2.40	3.36	1.20	1.68	0.60	0.84	12.90	18.06	3.20	4.48	1.20	1.68
1.50	2.10	0.80	1.12	0.40	0.56	1.10	1.54	0.50	0.70	0.23	0.32	6.10	8.54	1.40	1.96	0.40	0.56
0.70	0.98	0.22	0.31	0.10	0.14	0.50	0.70	0.13	0.18	0.06	0.08	2.70	3.78	0.30	0.42	0.10	0.14
0.23	0.32	0.06	0.08	0.03	0.04	0.14	0.20	0.04	0.06	0.02	0.03	0.80	1.12	0.10	0.14	0.03	0.04

- ① Minimum distance  $a_e$  between the channel end and the load point (HALFEN Bolt, locking plate)  $a_e \geq 40$  mm, The load point must not be located past the outer fixing positions.
- ② Do not exceed the bolt load capacity or the max. channel load bearing capacity.
- ③ For maximum point-load capacity:  
 $F_z = \max$ , load bearing capacity of the channel lips.
- ④ Take constructive measures to prevent failure caused by bulging, tilting and buckling.
- ⑤ On request.

All load capacities were calculated using the elastic-plastic method acc. to EN 1993-1, partial safety factor  $\gamma_F = 1.4$ ; deflection  $\leq l / 150$ .  
Determination of the allowable value  
**allow. F<sub>z</sub> = F<sub>Rd</sub> / 1.4.**

**Note:** For stainless steel framing channels the bending deflection value must be verified separately using the valid (elasticity) E-modulus.

# HALFEN INDUSTRIAL TECHNOLOGY

## Load Bearing Capacities for Welded or Bolted HALFEN Framing Channels

Hot-rolled HM Framing channels welded or bolted to structural elements

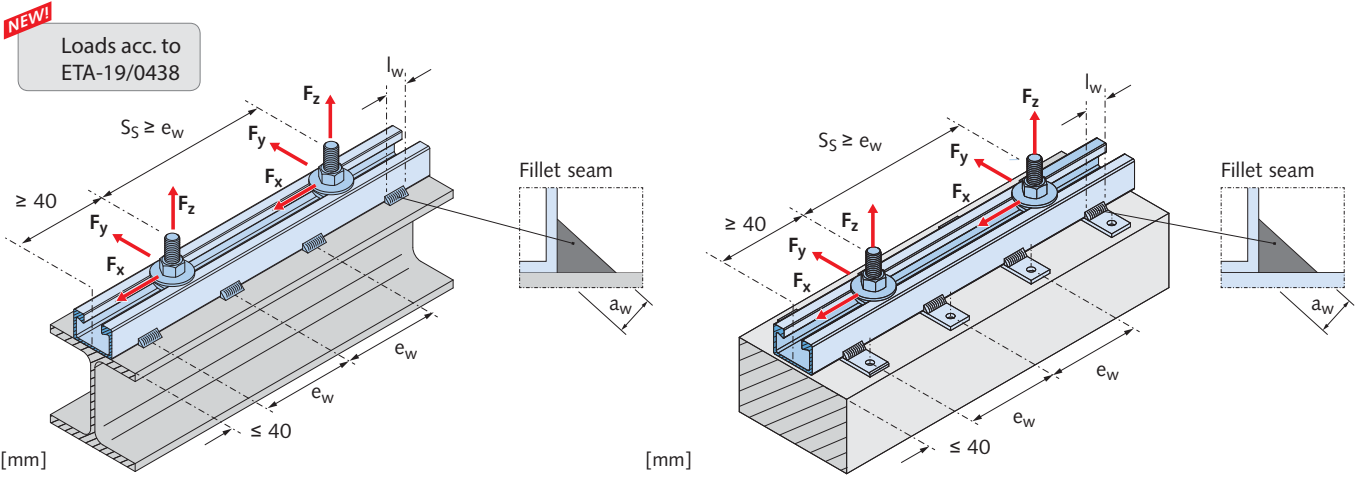

### Load bearing capacities for hot-rolled HM Framing channels, no serration

Hot rolled channels	Weld seams			Point-load bearing capacity ① ③				HALFEN Bolts
	a <sub>w</sub> [mm]	l <sub>w</sub> [mm]	e <sub>w</sub> [mm]	allowable loads F <sub>2</sub> [kN]		Design resistance values F <sub>Rd</sub> ① [kN]		spacings
				allow. F <sub>z</sub>	allow. F <sub>y</sub>	F <sub>z,Rd</sub>	F <sub>y,Rd</sub>	S <sub>s</sub>
HM 72/48	5	50	300	47.6	19.8	66.7	27.8	S <sub>s</sub> ≥ e <sub>w</sub>
HM 55/42	4	30	250	39.7	17.9	55.6	25.0	
HM 52/34	4	30	200	27.0	15.1	37.8	21.1	
HM 50/30	4	30	200	15.1	10.7	21.1	15.0	
HM 40/22	3	30	150	10.3	5.6	14.4	7.8	

③ Observe the bolt load capacities

① In cases of simultaneous loading in all directions the following criterion must be met:



$$\left(\frac{F_z}{\text{allow. } F_z}\right)^2 + \left(\frac{F_y}{\text{allow. } F_y}\right)^2 \leq 1$$

resp.

$$\left(\frac{F_{z,Ed}}{F_{z,Rd}}\right)^2 + \left(\frac{F_{y,Ed}}{F_{y,Rd}}\right)^2 \leq 1$$

F<sub>y</sub>, F<sub>z</sub> = existing load;  
F = allowable point-load capacity

resp.

F<sub>y,Ed</sub>, F<sub>z,Ed</sub> = Design values of action  
F<sub>y,Rd</sub>, F<sub>z,Rd</sub> = Design values of resistance  
(Design load capacities)

① The bearing capacities are for loads acting on the front edge of the channel. For off-set transverse load (e.g. stand-off installations) the bending moment of the bolt must be considered and superimposed with the tensile load, see page 71.

# HALFEN INDUSTRIAL TECHNOLOGY

## Load Bearing Capacities for Welded or Bolted HALFEN Framing Channels

Framing channels welded or bolted to structural elements

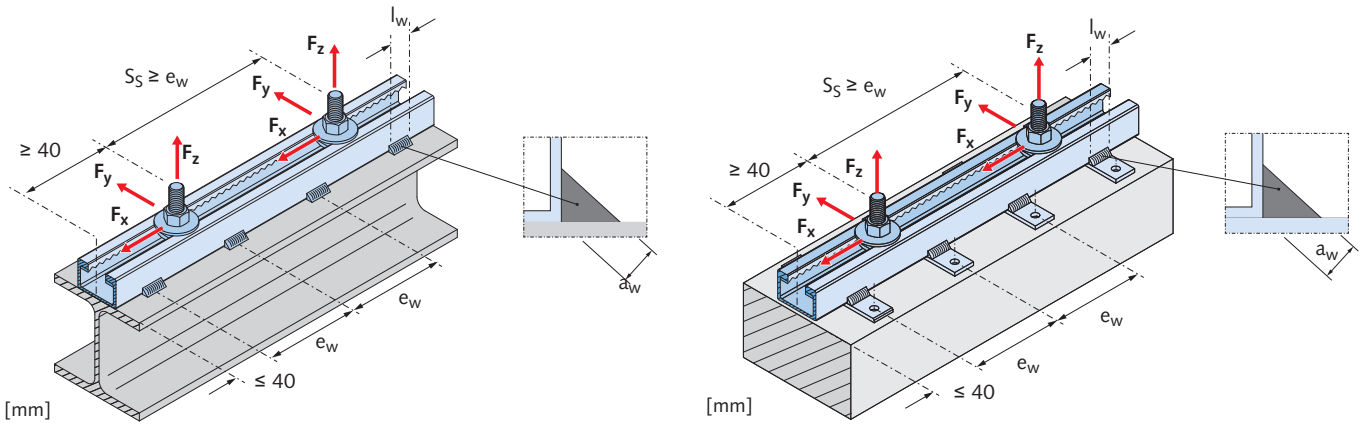

Load bearing capacities for hot-rolled serrated HZM Channels

Hot-rolled channels	Weld seams			Point-load bearing capacity ①						HALFEN Bolts	
	$a_w$ [mm]	$l_w$ [mm]	$e_w$ [mm]	allowable loads $F_{\text{②}}$ [kN]			Design resistance values $F_{\text{Rd}}$ ① [kN]			size	spacings
				allow. $F_z$	allow. $F_y$	allow. $F_x$	$F_{z,\text{Rd}}$	$F_{y,\text{Rd}}$	$F_{x,\text{Rd}}$	$\varnothing$ [mm]	$S_s$
HZM 64/44	5	40	250	38.1	12.5	27.0	53.3	17.4	37.8	M24	$S_s \ge e_w$
HZM 53/34	4	30	200	30.9	9.3	22.0/19.0③	43.3	13.1	30.8/26.6③	M20	
HZM 41/27	4	30	200	17.8	4.4	12.0	25.0	6.2	16.8	M16	
HZM 38/23	4	30	200	12.8	4.2	12.0	18.0	5.9	16.8	M16	
HZM 29/20	3	30	150	8.0	1.5	8.0	11.2	2.0	11.2	M12	

③ For stainless steel

① In cases of simultaneous loading in all directions the following criterion must be met:



$$\frac{F_z}{\text{allow. } F_z} + \frac{F_y}{\text{allow. } F_y} + \frac{F_x}{\text{allow. } F_x} \leq 1$$

resp.

$$\frac{F_{z,\text{Ed}}}{F_{z,\text{Rd}}} + \frac{F_{y,\text{Ed}}}{F_{y,\text{Rd}}} + \frac{F_{x,\text{Ed}}}{F_{x,\text{Rd}}} \leq 1$$

$F_x, F_y, F_z$  = existing load;  
allow.  $F$  = allowable point-load capacity

resp.

$F_{x,\text{Ed}}, F_{y,\text{Ed}}, F_{z,\text{Ed}}$  = Design values of action

$F_{x,\text{Rd}}, F_{y,\text{Rd}}, F_{z,\text{Rd}}$  = Design values of resistance

① The bearing capacities are for loads acting on the front edge of the channel. For off-set transverse load (e.g. stand-off installations) the bending moment of the bolt must be considered and superimposed with the tensile load, see page 71.

# HALFEN INDUSTRIAL TECHNOLOGY

## Load Bearing Capacities for Welded or Bolted HALFEN Framing Channels

Cold-rolled framing channels with and without serrated lips

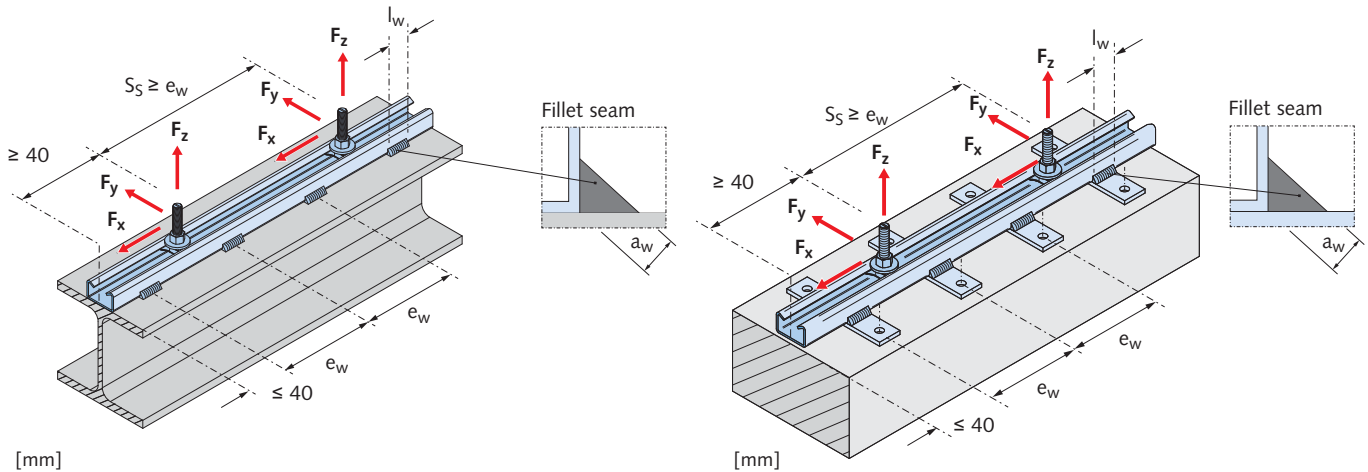

Load bearing capacities for welded or bolted cold-rolled framing channels

Cold-rolled profiles	Weld seams			Point-load bearing capacities ②				Longitudinal	
	a <sub>w</sub> [mm]	l <sub>w</sub> [mm]	e <sub>w</sub> [mm]	Tension α ≤ 60° F <sub>z</sub> [kN]		Shear γ < 60° F <sub>y</sub> [kN]		allow. F <sub>x</sub>	F <sub>x,Rd</sub>
				allow. F <sub>z</sub>	F <sub>z,Rd</sub>	allow. F <sub>y</sub>	F <sub>y,Rd</sub>		
HM 50/40	3	30	400	5.4	7.6	1.9	2.7	①	①
HZM 41/41	3	30	300	5.6	7.8	1.2	1.7	5.0	7.0
HZM 41/22	3	30	120	5.6	7.8	1.5	2.1	5.0	7.0
HM 41/41	3	30	300	5.6	7.8	1.2	1.7	①	①
HM 41/22	3	30	120	5.6	7.8	1.5	2.1		
HM 36/36	3	30	300	4.4	6.2	1.2	1.7		
HM 38/17	3	30	100	4.8	6.7	2.5	3.5		
HM 28/15	3	30	100	2.5	3.5	1.2	1.7		

① Recommended load bearing capacities in channel longitudinal direction for standard (non-serrated) channels can be found on the respective product page

② The bearing capacities are for loads acting on the front edge of the channel. For off-set transverse load (e.g. stand-off installations) the bending moment of the bolt must be considered and superimposed with the tensile stress, see page 71.



# HALFEN INDUSTRIAL TECHNOLOGY

## HALFEN Bolts – Bending moments

### Bending moments of HALFEN Bolts

#### Bending moments of HALFEN Bolts

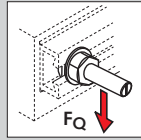

Recommended bolt bending moments from the front edge of the HALFEN Channel

#### Strength class

Thread $\phi$	4.6		8.8		A2-50; A4-50		A2-70; A4-70	
	allow. M	$M_{Rd}$ ①	allow. M	$M_{Rd}$ ①	allow. M	$M_{Rd}$ ①	allow. M	$M_{Rd}$ ①
M6	2.0	2.8	-	-	1.8	2.5	3.8	5.3
M8	5.0	7.0	-	-	4.4	6.2	9.4	13.2
M10	10.0	14.0	24.9	34.9	8.7	12.2	18.7	26.2
M12	17.5	24.5	43.7②	61.2②	15.3	21.4	32.8②	45.9②
M16	44.4	62.2	111.0③	155.4③	38.8	54.3	83.3③	116.6③
M20	86.5	121.1	216.4	303.0	75.7	106.0	162.3	227.2
M24	149.7	209.4	374.2	524.0	131.1	183.3	156.2	218.7
M27	221.9	310.7	554.8	776.7	-	-	-	-
M30	299.9	419.9	-	-	-	-	-	-

① Recommended design value of bending moment capability for HALFEN Bolts

② For HM/HL 28/15 channels the bending moment must be reduced to  $M_{Rd} = 42$  Nm resp. allow. M = 30 Nm

③ For HM/HL 38/17 channels the bending moment must be reduced to  $M_{Rd} = 91$  Nm resp. allow. M = 65 Nm

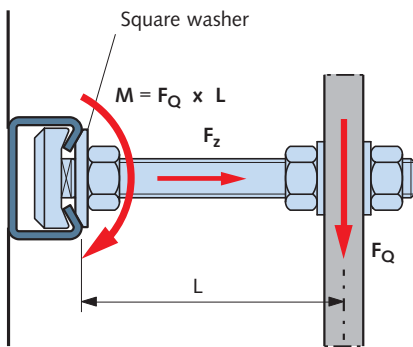

Always use square washers with stand-off installations.

In cases of bending with additional centric tension the action loads must be superimposed with the tensile load.



$$F_z \leq \text{allow. } F \cdot \left(1 - \frac{M}{\text{allow. } M}\right)$$

resp.

$$F_{z,Ed} \leq F_{Rd} \cdot \left(1 - \frac{M_{Ed}}{M_{Rd}}\right)$$

- $F_z$  = existing tension load
- allow.  $F_z$  = allowable load bearing capacity of the bolt
- $M$  = existing bending moment of the bolt
- allow.  $M$  = allowable bending moment of the bolt
- resp.
- $F_{z,Ed}$  = Design value for the existing tension load of the bolt
- $F_{z,Rd}$  = Design value for the resistance of the bolt
- $M_{Ed}$  = Design value for the existing bending moment of the bolt
- $M_{Rd}$  = Design value for bending moment resistance of the bolt

# HALFEN INDUSTRIAL TECHNOLOGY

## Framing Channels as Compression Elements

### HALFEN Framing channels as compression element – hot-rolled

Buckling acc. to EN 1993-1-1  
(Point-load applied at P)

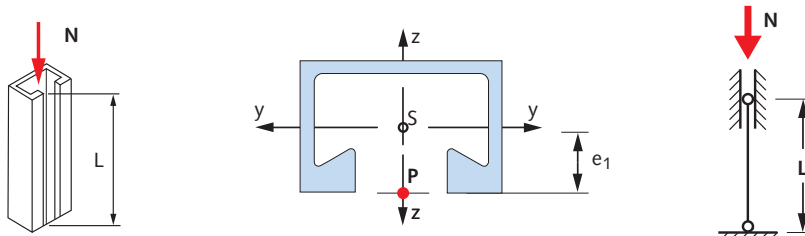

Table footnotes → see page 71

#### Hot-rolled channels – Load bearing capacities – buckling

Type	Cross section properties					N [kN] ①,② for profile lengths L [mm]										
	A [cm <sup>2</sup> ]	e <sub>1</sub> [cm]	I <sub>y</sub> [cm <sup>4</sup> ]	W <sub>y</sub> [cm <sup>3</sup> ]	W <sub>pl</sub> [cm <sup>3</sup> ]	500	1000	1500	2000	2500	3000	3500	4000	4500	5000	
HM 72/48	11.27	2.40	34.97	14.28	18.28	N <sub>Rd</sub>	104.6	81.6	62.0	50.0	40.0	32.2	26.4	21.8	18.4	15.6
						allow. N	74.7	58.3	44.3	35.7	28.6	23.0	18.9	15.6	13.1	11.1
HM 55/42	8.61	2.21	18.75	8.49	11.73	N <sub>Rd</sub>	79.0	57.5	43.0	32.8	25.1	19.8	15.8	12.9	10.7	9.0
						allow. N	56.4	41.1	30.7	23.4	17.9	14.1	11.3	9.2	7.6	6.4
HM 52/34	6.34	1.74	9.33	5.35	7.19	N <sub>Rd</sub>	50.4	34.6	25.3	18.5	13.9	10.7	8.5	6.8	5.6	4.7
						allow. N	36.0	24.7	18.1	13.2	9.9	7.6	6.1	4.9	4.0	3.4
HM 50/30	4.15	1.63	5.26	3.23	4.38	N <sub>Rd</sub>	31.8	21.4	15.3	11.0	8.2	6.3	4.9	4.0	3.2	2.7
						allow. N	22.7	15.3	10.9	7.9	5.8	4.5	3.5	2.8	2.3	1.9
HM 40/22	2.70	1.25	1.99	1.59	2.17	N <sub>Rd</sub>	18.2	11.2	7.3	5.0	3.5	2.6	—	—	—	—
						allow. N	13.0	8.0	5.2	3.5	2.5	1.9	—	—	—	—
HM 72/48 D	22.54	4.85	205.15	42.30	55.20	N <sub>Rd</sub>	195.2	169.2	148.0	128.0	110.0	98.0	87.0	77.0	68.5	61.0
						allow. N	139.4	120.9	105.7	91.4	78.6	70.0	62.1	55.0	48.9	43.6
HM 55/42 D	17.22	4.20	105.70	25.17	34.27	N <sub>Rd</sub>	155.0	130.0	109.0	90.0	78.0	67.0	57.5	46.3	43.0	37.5
						allow. N	110.7	92.9	77.9	64.3	55.7	47.9	41.1	33.1	30.7	26.8
HM 52/34 D	12.70	3.35	51.49	15.37	20.42	N <sub>Rd</sub>	97.0	80.0	64.5	53.5	45.0	37.5	31.8	26.9	23.1	20.0
						allow. N	69.3	57.1	46.1	38.2	32.1	26.8	22.7	19.2	16.5	14.3
HM 50/30 D	8.27	3.00	26.56	8.85	11.52	N <sub>Rd</sub>	61.5	49.0	38.5	31.7	26.0	21.5	17.9	15.0	12.8	11.0
						allow. N	43.9	35.0	27.5	22.6	18.6	15.4	12.8	10.7	9.1	7.9
HM 40/22 D	5.33	2.30	10.06	4.38	5.73	N <sub>Rd</sub>	37.0	27.5	20.9	16.1	12.6	10.0	8.1	6.7	5.6	4.7
						allow. N	26.4	19.6	14.9	11.5	9.0	7.1	5.8	4.8	4.0	3.4
HZM 64/44	9.10	2.30	23.83	10.36	13.66	N <sub>Rd</sub>	91.0	68.0	51.0	39.5	30.5	24.3	19.5	16.0	13.3	11.2
						allow. N	65.0	48.6	36.4	28.2	21.8	17.4	13.9	11.4	9.5	8.0
HZM 53/34	5.88	1.86	9.19	4.95	6.80	N <sub>Rd</sub>	51.8	35.0	25.5	18.5	13.9	10.6	8.4	6.8	5.6	4.7
						allow. N	37.0	25.0	18.2	13.2	9.9	7.6	6.0	4.8	4.0	3.3
HZM 41/27	4.31	1.51	3.90	2.57	3.74	N <sub>Rd</sub>	31.5	20.0	13.2	9.2	6.7	5.0	3.9	3.1	2.5	—
						allow. N	22.5	14.3	9.4	6.6	4.8	3.6	2.8	2.2	1.8	—
HZM 38/23	3.10	1.33	2.11	1.59	2.31	N <sub>Rd</sub>	20.7	12.5	7.9	5.3	3.8	2.8	2.2	—	—	—
						allow. N	14.8	8.9	5.6	3.8	2.7	2.0	1.6	—	—	—
HZM 29/20	1.99	1.12	1.02	0.91	1.31	N <sub>Rd</sub>	12.5	7.1	4.3	2.8	—	—	—	—	—	—
						allow. N	8.9	5.1	3.1	2.0	—	—	—	—	—	—
HZM 64/44 D	18.21	4.40	127.94	29.08	38.23	N <sub>Rd</sub>	171.0	144.5	122.0	102.0	88.5	76.5	66.0	57.5	50.0	43.9
						allow. N	122.1	103.2	87.1	72.9	63.2	54.6	47.1	41.1	35.7	31.4
HZM 53/34 D	11.75	3.40	46.38	13.64	18.14	N <sub>Rd</sub>	100.0	81.0	63.5	53.0	43.5	36.3	30.3	25.5	21.7	18.8
						allow. N	71.4	57.9	45.4	37.9	31.1	25.9	21.6	18.2	15.5	13.4
HZM 41/27 D	8.62	2.70	19.91	7.37	10.22	N <sub>Rd</sub>	65.5	49.5	38.0	29.8	23.5	18.9	15.3	12.7	10.6	9.0
						allow. N	46.8	35.4	27.1	21.3	16.8	13.5	10.9	9.1	7.6	6.4
HZM 38/23 D	6.19	2.30	10.04	4.36	6.00	N <sub>Rd</sub>	43.6	30.9	23.4	17.5	13.5	10.6	8.5	6.9	5.8	4.9
						allow. N	31.1	22.1	16.7	12.5	9.6	7.6	6.1	4.9	4.1	3.5
HZM 29/20 D	3.97	2.00	5.12	2.56	3.49	N <sub>Rd</sub>	27.9	19.1	13.8	10.0	7.6	5.9	4.6	3.8	3.1	2.6
						allow. N	19.9	13.6	9.9	7.1	5.4	4.2	3.3	2.7	2.2	1.8

# HALFEN INDUSTRIAL TECHNOLOGY

## Framing Channels as Compression Elements

### HALFEN Framing channels as compression elements – cold-rolled

Flexural buckling acc to. EN 1993-1-1  
(Point-load applied at P)

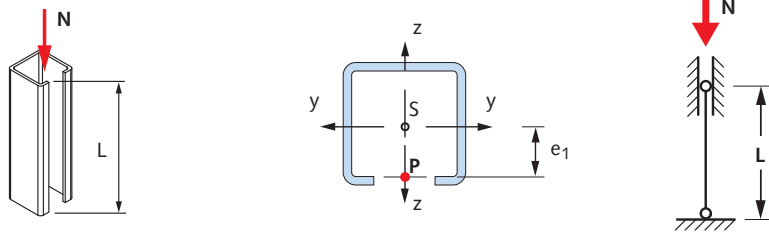

Cold-rolled channels – Load bearing capacities – buckling

Type	Cross-section properties					N [kN] ①,② for element length L [mm]										
	A [cm²]	e <sub>1</sub> [cm]	I <sub>y</sub> [cm⁴]	W <sub>y</sub> [cm³]	W <sub>pl</sub> [cm³]	500	1000	1500	2000	2500	3000	3500	4000	4500	5000	
	[kN]															
HM 50/40	4.26	2.18	8.64	3.96	5.53	N <sub>Rd</sub>	33.2	24.6	18.5	14.2	11.1	8.8	7.0	5.8	4.8	4.1
						allow. N	23.7	17.6	13.2	10.1	7.9	6.3	5.0	4.1	3.5	2.9
HM 41/41	3.40	2.31	7.47	3.24	4.57	N <sub>Rd</sub>	26.3	19.7	15.0	11.7	9.2	7.3	6.0	4.9	4.1	3.5
						allow. N	18.8	14.1	10.7	8.4	6.6	5.2	4.3	3.5	2.9	2.5
HM 36/36	2.80	2.07	4.54	2.19	3.19	N <sub>Rd</sub>	19.7	14.1	10.6	8.0	6.1	4.8	3.9	3.2	2.6	2.2
						allow. N	14.1	10.1	7.5	5.7	4.4	3.4	2.8	2.3	1.9	1.6
HM 28/28	1.73	1.58	1.70	1.08	1.54	N <sub>Rd</sub>	11.4	7.5	5.2	3.7	2.7	-	-	-	-	-
						allow. N	8.1	5.4	3.7	2.6	2.0	-	-	-	-	-
HZM 41/41	3.36	2.33	7.34	3.15	4.48	N <sub>Rd</sub>	25.5	19.3	14.6	11.4	9.0	7.2	5.8	4.8	4.0	3.4
						allow. N	18.2	13.8	10.4	8.1	6.4	5.1	4.1	3.4	2.9	2.4
HZM 41/41 D	6.71	4.13	36.45	8.83	12.09	N <sub>Rd</sub>	49.0	41.5	35.0	29.1	25.3	21.8	18.8	16.3	14.2	12.5
						allow. N	35.0	29.6	25.0	20.8	18.1	15.6	13.4	11.6	10.1	8.9
HL 50/40	3.73	1.95	7.14	3.65	4.68	N <sub>Rd</sub>	31.5	22.8	16.9	12.8	9.8	7.7	6.1	5.0	4.1	3.5
						allow. N	22.5	16.3	12.1	9.1	7.0	5.5	4.4	3.6	2.9	2.5
HL 41/41	2.98	2.14	6.07	2.84	3.82	N <sub>Rd</sub>	23.8	17.5	13.2	10.1	7.9	6.2	5.0	4.1	3.4	2.9
						allow. N	17.0	12.5	9.4	7.2	5.6	4.4	3.6	2.9	2.4	2.0
HL 36/36	2.42	1.85	3.65	1.97	2.64	N <sub>Rd</sub>	18.3	12.7	9.4	7.0	5.3	4.1	3.2	2.6	-	-
						allow. N	13.1	9.1	6.7	5.0	3.8	2.9	2.3	1.9	-	-
HL 28/28	1.48	1.39	1.33	0.95	1.25	N <sub>Rd</sub>	10.4	6.7	4.5	3.1	2.3	-	-	-	-	-
						allow. N	7.4	4.8	3.2	2.2	1.6	-	-	-	-	-
HZL 63/63 ③	7.09	3.01	33.07	10.06	13.51	N <sub>Rd</sub>	65.0	53.2	43.3	35.4	29.7	24.8	20.9	17.7	15.2	13.1
						allow. N	46.4	38.0	30.9	25.3	21.2	17.7	14.9	12.6	10.9	9.4
HZL 41/41	2.90	2.18	5.87	2.69	3.70	N <sub>Rd</sub>	22.5	16.7	12.6	9.7	7.5	6.0	4.8	4.0	3.3	2.8
						allow. N	16.1	11.9	9.0	6.9	5.4	4.3	3.4	2.8	2.3	2.0

① N<sub>Rd</sub> = Design value of resistance  
allow. N = allowable load

② allow. N = N<sub>Rd</sub> / 1.4; E = 170 000 N/mm<sup>2</sup>

③ allow. N = N<sub>Rd</sub> / 1.4; E = 210 000 N/mm<sup>2</sup>



#### NOTE:

For higher excentricity "e > e<sub>1</sub>" a flexural buckling analysis according to Eurocode 3 is necessary

# HALFEN INDUSTRIAL TECHNOLOGY

## Applications in Mechanical and Plant Engineering

### Information on dimensioning

When designing an adjustable assembly connection the external load  $F_i$  must be less or equal to the minimum allowable load of the HALFEN Bolt  $F_s$  and the maximum point-load capacity, i.e. the bending load capacity of the HALFEN Framing channel  $F_z$ .  
 $F_i \leq \text{MIN} (F_{\text{Bolt}}; F_{\text{Channel}})$ ;  $F_{\text{Channel}} \rightarrow$  see page 61 ff.

Design value of the resistance:  $F_{R,d} = 1.4 \times F$  (Forces)

Design value of the moment resistance:  $M_{R,d} = 1.4 \times M$  (Moments)

All following load specifications are allowable loads.

### Symbols and definitions used in mechanical engineering – steel construction industry

#### 1. Halfenschrauben

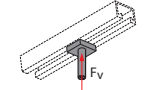
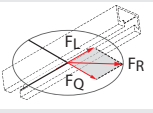
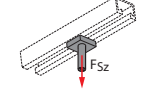
$F_v$		<b>Preload, bolt</b> The preload for the bolt occurs by applying a torque on the bolt and is calculated according to VDI 2230 guidelines.
$F_R$		<b>Resulting load</b> The resulting load $F_R$ is the vector addition of the external loads $F_L$ in the longitudinal channel direction and the external load $F_Q$ transverse to the longitudinal channel direction; the resulting force is frictionally connected to the channel. $F_R = \sqrt{(F_L^2 + F_Q^2)}$
$F_{sz}$		<b>Loads in the longitudinal bolt direction</b> The load $F_{sz}$ is an external load through the screws longitudinal axis, perpendicular to the channel surface and is transferred positive-locked to the channel.

### Symbols and definitions used in mechanical engineering – steel construction industry

#### 2. Framing channels

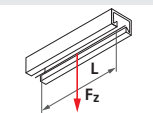
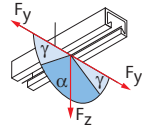
$F_z$		<b>Maximum point-load-carrying capacity – centric load</b> The load carrying capacity of the channel lips is decisive. Load figures are only valid for continuous welded channels or for intermittent welds according to the table on page 68 ff. In all other cases the suitability of the welding seam must be checked.
$F_y$		<b>Load capacity of the channels under transverse load angle <math>\gamma &lt; 60^\circ</math></b> Allowable load for a defined angle to the welded or bolted channels.
$F_z$		<b>Load capacity of the channels under transverse load angle <math>\alpha \leq 60^\circ</math></b> Allowable load for a defined load angle to the welded or bolted channels.

The load  $F_{sz}$  along the screw longitudinal axis must be less or equal to the maximum point-load capacity of the framing channel  $F_z$ .

$$F_{sz} \leq F_z$$

The load  $F_Q$  transverse to the longitudinal channel direction must be less or equal to the load capacity transverse to the longitudinal channel direction of the framing channel  $F_y$ .

$$F_Q \leq F_y$$

# HALFEN INDUSTRIAL TECHNOLOGY

## Applications in Mechanical and Plant Engineering

### Required bolt length $L_{bolt}$

The required bolt length  $L_{bolt}$  is the sum of the clamp thickness  $KD$  and the minimum required supplement  $L_{sup}$ .

$$L_{bolt} = KD + L_{sup}$$

$$L_{sup} = h + m + v$$

The thread protrusion  $v$  has to extend above the nut at least  $0.5 \times$  the nut height  $m$  (DIN EN 24032, regulation for nuts).

**Minimum required supplement  $L_{sup}$**   
according to the table below

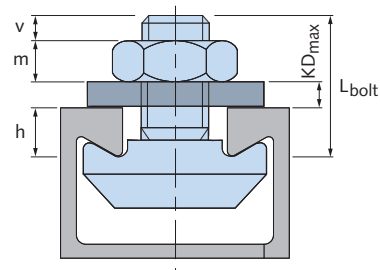

Minimum required supplement for HALFEN Bolts (heavy duty framing systems) [mm]

Thread	HM 72/48	HM 55/42	HM 52/34	HM 50/30	HM 49/30	HM 40/22	HM 40/25	HM 422	HZM 64/44	HZM 53/34	HZM 41/27	HZM 38/23	HZM 29/20	HM 50/40	HM 486
M6	-	-	-	-	-	-	-	-	-	-	-	-	-	-	-
M8	-	-	-	-	-	-	-	-	-	-	-	-	12	-	-
M10	-	25	24	20	20	18	18	18	-	-	18	17	15	-	-
M12	-	29	27	24	23	22	22	22	-	-	21	21	16	19	18
M16	-	35	33	30	29	28	28	28	-	28	27	27	20	23	22
M20	42	39	38	34	34	-	-	-	34	32	-	-	-	29	28
M24	47	-	-	-	-	-	-	-	40	-	-	-	-	33	32
M27	50	-	-	-	-	-	-	-	-	-	-	-	-	-	-
M30	53	-	-	-	-	-	-	-	-	-	-	-	-	-	-

Minimum required supplement for HALFEN Bolts (medium duty framing systems) [mm]

Thread	HZL 63/63	HM 41/41	HM 41/22	HM 41/62	HM 41/83
M6	-	-	-	-	-
M8	-	18	18	18	18
M10	-	19	19	19	19
M12	19	23	23	23	23
M16	23	29	29	29	29
M20	29	-	-	-	-
M24	33	-	-	-	-

Minimum required supplement for HALFEN Bolts (light duty framing systems) [mm]

Thread	HM 36/36	HM 38/17	HM 28/28	HM 26/26	HM 28/15	HM 315	HM 20/12
M6	-	-	-	-	-	-	-
M8	-	-	10	9	10	9	9
M10	15	15	13	12	13	12	12
M12	18	19	14	13	14	14	-
M16	24	25	18	17	18	17	-

# HALFEN INDUSTRIAL TECHNOLOGY

## Applications in Mechanical and Plant Engineering

### Static and dynamic tension tests

The transferability of static and dynamic loads for adjustable assembly systems was intensely studied in cooperation with the State Material Testing Institute at the TU Darmstadt (Technical University Darmstadt).

Following VDI guideline 2230, the data acquired from bolt tightening tests, static and dynamic traction tests form the basis of algorithms used for calculating adjustable assembly systems.

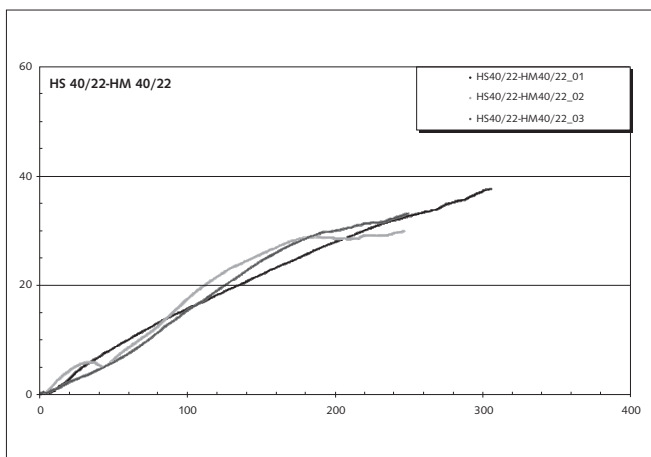

Graph: tightening test results

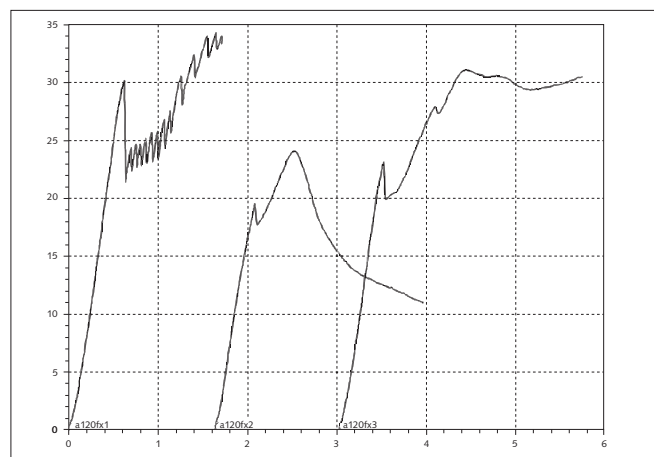

Graph: tension test results



Tightening test



Tension test



Fatigue test

# HALFEN INDUSTRIAL TECHNOLOGY

## Applications in Mechanical and Plant Engineering

### Generating the preload force $F_V$

During assembly of bolt connections the torque  $M_A$  induces a preload force  $F_V$  in the bolt, which clamps the component to the framing channel. The preload force  $F_V$  depends on the torque  $M_A$ , the friction coefficients  $\mu_G$  of the bolt thread and  $\mu_K$  on the nut contact surface.

The preload forces for stainless steel bolts 50/70 and for HALFEN Bolts in steel, strength class 4.6 and 8.8 are specified in the following tables (ref. Rohloff-Matek).

The data listed for the torque  $M_A$  are recommended values. Standard delivery condition for HALFEN Bolts is non-lubricated, installation ready.

The friction coefficients  $\mu_G$  and  $\mu_K$  are 0.24.

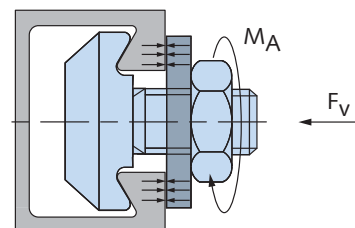

Preload force  $F_V$ , strength class 4.6 [kN]

	$M_A$ [Nm]	Friction coefficient $\mu_G = \mu_K$												
		0.12	0.14	0.16	0.18	0.20	0.22	0.24	0.26	0.28	0.30	0.32	0.34	0.36
M6	3	3.0	2.6	2.3	2.1	1.9	1.8	1.6	1.5	1.4	1.3	1.2	1.2	1.1
M8	8	6.1	5.3	4.7	4.3	3.9	3.5	3.3	3.0	2.8	2.7	2.5	2.4	2.2
M10	15	9.2	8.0	7.1	6.4	5.8	5.3	4.9	4.6	4.3	4.0	3.8	3.6	3.4
M12	25	12.9	11.3	10.0	9.0	8.2	7.5	6.9	6.4	6.0	5.6	5.3	5.0	4.7
M16	65	25.6	22.3	19.8	17.8	16.1	14.8	13.6	12.6	11.8	11.0	10.4	9.8	9.2
M20	130	40.8	35.6	31.6	28.4	25.7	23.6	21.7	20.1	18.8	17.6	16.5	15.6	14.8
M24	230	60.5	52.8	46.8	42.0	38.2	34.9	32.2	29.9	27.8	26.1	24.5	23.1	21.9
M27	340	79.8	69.5	61.5	55.2	50.0	45.8	42.1	39.1	36.4	34.1	32.0	30.2	28.6
M30	460	96.7	84.2	74.6	67.0	60.7	55.6	51.2	47.5	44.2	41.4	38.9	36.7	34.8

Preload force  $F_V$ , strength class 8.8 [kN]

	$M_A$ [Nm]	Friction coefficient $\mu_G = \mu_K$												
		0.12	0.14	0.16	0.18	0.20	0.22	0.24	0.26	0.28	0.30	0.32	0.34	0.36
M8	20	15.2	13.3	11.8	10.6	9.7	8.9	8.2	7.6	7.1	6.6	6.2	5.9	5.6
M10	40	24.4	21.4	19.0	17.1	15.5	14.2	13.1	12.2	11.4	10.7	10.0	9.5	9.0
M12	70	36.1	31.6	28.1	25.2	22.9	21.0	19.4	18.0	16.8	15.7	14.8	14.0	13.2
M16	180	70.8	61.8	54.8	49.2	44.6	40.9	37.7	34.9	32.6	30.5	28.7	27.1	25.6
M20	360	113.1	98.6	87.5	78.5	71.3	65.2	60.1	55.8	52.0	48.7	45.8	43.2	40.9
M24	620	163.1	142.3	126.2	113.3	102.8	94.1	86.8	80.5	75.0	70.3	66.1	62.3	59.0
M27	900	211.2	183.9	162.8	146.1	132.5	121.1	111.6	103.5	96.4	90.2	84.8	80.0	75.7
M30	1200	252.1	219.7	194.7	174.7	158.5	145.0	133.6	123.8	115.4	108.1	101.6	95.8	90.7

Preload force  $F_V$ , strength class 50

	$M_A$ [Nm]	Friction coefficient $\mu_G = \mu_K$												
		0.12	0.14	0.16	0.18	0.20	0.22	0.24	0.26	0.28	0.30	0.32	0.34	0.36
M6	3	3.0	2.6	2.3	2.1	1.9	1.8	1.6	1.5	1.4	1.3	1.2	1.2	1.1
M8	7	5.3	4.6	4.1	3.7	3.4	3.1	2.9	2.7	2.5	2.3	2.2	2.1	2.0
M10	14	8.6	7.5	6.7	6.0	5.4	5.0	4.6	4.3	4.0	3.7	3.5	3.3	3.1
M12	25	12.9	11.3	10.0	9.0	8.2	7.5	6.9	6.4	6.0	5.6	5.3	5.0	4.7
M16	60	23.6	20.6	18.3	16.4	14.9	13.6	12.6	11.6	10.9	10.2	9.6	9.0	8.5
M20	120	37.7	32.9	29.2	26.2	23.8	21.7	20.0	18.6	17.3	16.2	15.3	14.4	13.6
M24	200	52.6	45.9	40.7	36.6	33.2	30.4	28.0	26.0	24.2	22.7	21.3	20.1	19.0

Preload force  $F_V$ , strength class 70

	$M_A$ [Nm]	Friction coefficient $\mu_G = \mu_K$												
		0.12	0.14	0.16	0.18	0.20	0.22	0.24	0.26	0.28	0.30	0.32	0.34	0.36
M6	7	7.0	6.2	5.5	4.9	4.5	4.1	3.8	3.5	3.3	3.1	2.9	2.7	2.6
M8	15	11.4	10.0	8.9	8.0	7.2	6.6	6.1	5.7	5.3	5.0	4.7	4.4	4.2
M10	30	18.3	16.0	14.3	12.8	11.7	10.7	9.9	9.2	8.5	8.0	7.5	7.1	6.7
M12	50	25.8	22.6	20.0	18.0	16.4	15.0	13.8	12.9	12.0	11.2	10.6	10.0	9.4
M16	125	49.2	42.9	38.0	34.2	31.0	28.4	26.2	24.3	22.6	21.2	19.9	18.8	17.8
M20	245	76.9	67.1	59.5	53.5	48.5	44.4	40.9	38.0	35.4	33.1	31.2	29.4	27.8
M24	420	110.5	96.4	85.5	76.8	69.7	63.8	58.8	54.5	50.8	47.6	44.8	42.2	40.0



# HALFEN INDUSTRIAL TECHNOLOGY

## Applications in Mechanical and Plant Engineering

### Transfer of static loads

External loads  $F_L$ ,  $F_Q$  and  $F_{S_z}$  acting on the building component are transferred to the bolt connection by clamping.

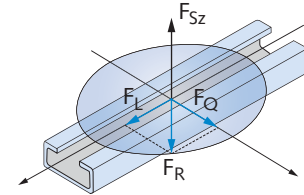

Force  $F_{S_z}$  acts positively in the bolt longitudinal axis.

Force  $F_L$  acting in and  $F_Q$  acting transverse to the longitudinal channel direction are transferred frictionally through the component-channel surface and are added to the resulting force  $F_R$ :

$$F_R = \sqrt{F_L^2 + F_Q^2}$$

Transfer of the friction force  $F_R$  requires a normal force  $F_N$  acting in the bolt longitudinal axis:

$$F_N = \frac{F_R}{\mu_T}$$

The minimum required clamping force  $F_{K,req}$  is a result of the two forces  $F_N$  and  $F_{S_z}$  acting in the bolt longitudinal axis:

$$F_{K,req} = F_N + F_{S_z} = \frac{F_R}{\mu_T} + F_{S_z}$$

When designing the bolt connection the bolt tightening procedure and the bolt setting behavior must be considered in accordance with VDI guideline 2230. The setting factor  $S_{set}$  is intended as a safety factor as the setting force loss for adjustable bolt connections is difficult to calculate using VDI 2230.

Therefore the minimum necessary assembly preloading strength  $F_{M, min}$  is:

$$F_{M, min} = S_{set} \times F_{K, req}$$

Taking the bolt tightening procedure into consideration with the tightening factor  $\alpha_A$  the maximum necessary assembly preloading force  $F_{M, max}$  calculates at:

$$F_{M, max} = \alpha_A \times F_{M, min} = \alpha_A \times S_{set} \times \left( \frac{F_R}{\mu_T} + F_{S_z} \right)$$

The maximum required assembly preloading force  $F_{M, max}$  must be smaller than the preloading force  $F_V$  produced by the bolt tightening procedure moment  $M_A$ :

$$F_{M, max} \leq F_V$$

The allowable loads for channel assembly systems are shown for **delivery condition** ( $\mu_G = \mu_K = 0.24$ ) and for **lubricated bolts** ( $\mu_G = \mu_K = 0.14$ ) in the tables on page 79.

The values for  $F_R$  apply only to transverse force requirements ( $F_{S_z} = 0$ ), the values for  $F_{S_z}$  for pure traction force requirement ( $F_R = 0$ ).

When overlaying the transverse force  $F_R$  and longitudinal force  $F_{S_z}$  apply the formulas listed right for the maximum assembly preloading force  $F_{M, max}$ .



# HALFEN INDUSTRIAL TECHNOLOGY

## Applications in Mechanical and Plant Engineering

### Allowable Loads

Allowable loads $F_R$ and $F_{S_z}$ - channel bolt connection								
Strength class 4.6								
Thread	$M_A$ [Nm]	Delivery condition $\mu_G = \mu_K = 0.24$			Lubricated $\mu_G = \mu_K = 0.14$			$F_Z$ [kN]
		$F_V$ [kN]	$F_R$ [kN]	$F_Z$ [kN]	$F_V$ [kN]	$F_R$ [kN]	$F_Z$ [kN]	
M6	3	1.6	0.2	0.7	2.6	0.3	1.1	
M8	8	3.3	0.3	1.4	5.3	0.6	2.2	
M10	15	4.9	0.5	2.1	8.0	0.8	3.3	
M12	25	6.9	0.7	2.9	11.3	1.2	4.7	
M16	65	13.6	1.4	5.7	22.3	2.3	9.3	
M20	130	21.7	2.3	9.0	35.6	3.7	14.8	
M24	230	32.2	3.4	13.4	52.8	5.5	22.0	
M27	340	42.1	4.4	17.6	69.5	7.2	28.9	
M30	460	51.2	5.3	21.3	84.2	8.8	35.1	

Allowable loads $F_R$ and $F_{S_z}$ - channel bolt connection								
Strength class 8.8								
Thread	$M_A$ [Nm]	Delivery condition $\mu_G = \mu_K = 0.24$			Lubricated $\mu_G = \mu_K = 0.14$			$F_Z$ [kN]
		$F_V$ [kN]	$F_R$ [kN]	$F_Z$ [kN]	$F_V$ [kN]	$F_R$ [kN]	$F_Z$ [kN]	
M10	40	13.1	1.4	5.5	21.4	2.2	8.9	
M12	70	19.4	2.0	8.1	31.6	3.3	13.2	
M16	180	37.7	3.9	15.7	61.8	6.4	25.7	
M20	360	60.1	6.3	25.1	98.6	10.3	41.1	
M24	620	86.8	9.0	36.2	142.3	14.8	59.3	
M27	900	111.6	11.6	46.5	183.9	19.2	76.6	

Allowable loads $F_R$ and $F_{S_z}$ - channel bolt connection								
Strength class 50								
Thread	$M_A$ [Nm]	Delivery condition $\mu_G = \mu_K = 0.24$			Lubricated $\mu_G = \mu_K = 0.14$			$F_Z$ [kN]
		$F_V$ [kN]	$F_R$ [kN]	$F_Z$ [kN]	$F_V$ [kN]	$F_R$ [kN]	$F_Z$ [kN]	
M8	7	2.9	0.3	1.4	4.6	0.6	2.2	
M10	14	4.6	0.5	2.1	7.5	0.8	3.4	
M12	25	6.9	0.7	2.9	11.3	1.2	4.7	
M16	60	12.6	1.3	5.3	20.6	2.2	8.6	
M20	120	20.0	2.1	8.4	32.9	3.4	13.8	
M24	200	28.0	2.9	11.7	45.9	4.8	19.2	

Allowable loads $F_R$ and $F_{S_z}$ - channel bolt connection								
Strength class 70								
Thread	$M_A$ [Nm]	Delivery condition $\mu_G = \mu_K = 0.24$			Lubricated $\mu_G = \mu_K = 0.14$			$F_Z$ [kN]
		$F_V$ [kN]	$F_R$ [kN]	$F_Z$ [kN]	$F_V$ [kN]	$F_R$ [kN]	$F_Z$ [kN]	
M8	15	6.1	0.6	2.6	10.0	1.0	4.2	
M10	30	9.9	1.0	4.1	16.0	1.7	6.7	
M12	50	13.8	1.4	5.8	22.6	2.4	9.4	
M16	125	26.2	2.7	10.9	42.9	4.5	17.9	
M20	245	40.9	4.3	17.1	67.1	7.0	28.0	
M24	420	58.8	6.1	24.5	96.4	10.0	40.2	

The provided data is based on the following failure modes and values:

Failure mode for transverse force load	$F_R$ : component slippage
Failure mode for longitudinal force load	$F_{S_z}$ : component separation
Friction coefficient in connection:	$\mu_T = 0.25$
Tightening factor (electrical-audible torque wrench):	$\alpha_A = 2.0$
Safety factor setting of bolt connection:	$S_{set} = 1.2$

The force  $F_Q$  transverse to the longitudinal channel direction must be smaller or equal to the load capacity transverse to the longitudinal channel direction of the HALFEN Framing channel  $F_y$  (→ see table on page 66).

$$F_Q \leq F_y$$

The force in the longitudinal bolt direction  $F_{S_z}$  must be smaller or equal to the maximum point-load capacity of the HALFEN Framing channel  $F_z$  (→ see table on page 66).

$$F_{S_z} \leq F_z$$

# HALFEN INDUSTRIAL TECHNOLOGY

## Applications in Mechanical and Plant Engineering

### Point-load capacities for HALFEN Framing channels

For welded and dowel-fixed HALFEN Framing channels

#### Point-load capacities for hot-rolled, framing channels

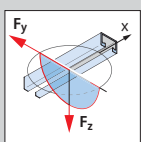

hot-rolled channels	allow. $F_z$ [kN]	allow. $F_y$ [kN]
HM 72/48	47.6	19.8
HM 55/42	39.7	17.9
HM 52/34	27.0	15.1
HM 50/30	15.1	10.7
HM 40/22	10.3	5.6
HZM 64/44	38.1	12.5
HZM 53/34	30.9	9.3
HZM 41/27	17.8	4.4
HZM 38/23	12.8	4.2
HZM 29/20	8.0	1.5

Observe the notes in the table on page 68 – 69!

#### Point-load capacities for cold-rolled, framing channels

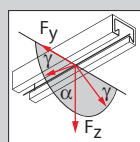

cold-rolled channels	tension $\alpha \leq 60^\circ$ allow. $F_z$ [kN]	transverse tension $\gamma < 60^\circ$ allow. $F_y$ [kN]
HM 50/40	5.4	1.9
HZM 41/41	5.6	1.2
HZM 41/22	5.6	1.5
HM 41/41	5.6	1.2
HM 41/22	5.6	1.5
HM 36/36	4.4	1.2
HM 38/17	4.8	2.5
HM 28/15	2.5	1.2
-	-	-
-	-	-

Observe the notes in the table on page 70 !

#### Example:

Specified: external load in longitudinal channel direction  
external load transverse to the longitudinal channel direction  
external load in longitudinal bolt direction  
friction between component – channel  
setting factor  
tightening factor

$$F_L = 1.5 \text{ kN}$$

$$F_Q = 0.5 \text{ kN}$$

$$F_{S_z} = 2.0 \text{ kN}$$

$$\mu_T = 0.25$$

$$S_{set} = 1.2$$

$$\alpha_A = 2$$

Selected framing channel HM 50/30

Resulting load  $F_R$  1.58 kN

Minimum required assembly preloading force  $F_{M \min}$  10 kN

Maximum required assembly preloading force  $F_{M \max}$  20 kN

Selected HALFEN Bolt 50/30, 4.6 in delivery condition M 20

Preloading  $F_V$  21.7 kN

Comparison of external loads with permissible load of channel HM 50/30 with values in table above

$$F_z = 15.1 \text{ kN} > F_{S_z} \quad \checkmark$$

$$F_y = 10.7 \text{ kN} > F_Q \quad \checkmark$$

#### Result:

Selected framing channel: HM 50/30

Selected HALFEN Bolt: HS 50/30 – M20 - scl. 4.6 in standard delivery condition

# HALFEN INDUSTRIAL TECHNOLOGY

## Applications in Mechanical and Plant Engineering

### Transfer of dynamic loads

Hot-rolled assembly channels are suitable for the transfer of dynamic loads when used in conjunction with nibbed HALFEN Bolts (type HSR) or serrated HALFEN Bolts (type HZS).

The dynamic load  $F_{L\ dyn}$  acting on the building component in the longitudinal channel direction, is frictionally transferred via the channel/bolt contact surface to the channel.

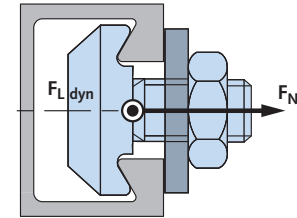

A clamping force  $F_{K\ req}$  acting in the bolt longitudinal axis is necessary for friction transfer  $F_{L\ dyn}$ :

$$F_{K\ req} = \frac{F_{L\ dyn}}{\mu_T}$$

According to VDI guideline 2230 when designing the bolt connection, the bolt tightening procedure and the bolt setting behaviour must be considered.

The setting factor  $S_{set}$  is intended as a safety factor as the setting force loss for adjustable bolt connections is difficult to calculate using VDI 2230.

$$F_{M\ min} = S_{Set} \times F_{K\ erf}$$

Therefore the minimum necessary assembly preload strength  $F_{M\ min}$  is:

$$F_{M\ max} = \alpha_A \times S_{Set} \times \frac{F_{L\ dyn}}{\mu_T}$$

Taking the bolt tightening procedure into consideration with the tightening factor  $\alpha_A$  the maximum necessary assembly preload force  $F_{M\ max}$  is calculated at:

The calculated maximum assembly preload force  $F_{M\ max}$  must be smaller or equal to the preload force  $F_V$  of the bolt (see table):

$$F_{M\ max} \leq F_V$$

The permissible dynamic loads for channel assembly systems are shown as for **delivery condition** ( $\mu_G = \mu_K = 0.24$ ) and for a lubricated condition ( $\mu_G = \mu_K = 0.14$ ) in the following table.

The values are valid for **pure alternating stress with a transverse force in the longitudinal channel direction**.

The stress ratio is  $R = -1$  and the maximum load changes value is  $N = 10^6$ .

Allowable dynamic loads $F_{L\ dyn}$ – channel-bolt connection							
HALFEN Bolts HSR and HZS, strength class 8.8							
		Delivery condition			Lubricated		
		$\mu_G = \mu_K = 0.24$			$\mu_G = \mu_K = 0.14$		
Thread	$M_A$ [Nm]	$F_V$ [kN]	$F_{L\ dyn}$ [kN]	Typ	$F_V$ [kN]	$F_{L\ dyn}$ [kN]	Type
M12	80	22.3	2.3	HZS	36.2	3.8	HZS
M16	120	25.2	2.6	HZS	41.3	4.3	HZS
M16	200	42.1	4.4	HSR	68.8	7.2	HSR
M20	400	67.2	7.0	HSR	109.9	11.4	HSR

This data is based on the following failure modes and values:

Failure mode for transverse force load  $F_{L\ dyn}$ : component slippage  
 Friction coefficient in connection:  $\mu_T = 0.25$   
 Tightening factor (electrical-audible torque wrench):  $\alpha_A = 2.0$   
 Safety factor setting of bolt joint:  $S_{set} = 1.2$

Individual calculation of bolted connections is achieved using the formulas and tables listed above.

## HALFEN INDUSTRIAL TECHNOLOGY

### Tender texts

#### Invitation to tender – examples for HALFEN Framing channels and cantilevers

##### **HALFEN FRAMING CHANNELS HM 52/34 - WB - 6070**

HALFEN – Framing channel, HM 52/34 hot-rolled channel, with CE marking in accordance with ETA 19/0438

Material: (WB) Mill finish steel, delivered in 6.07 metre units, cut to specified length and installed. For adjustable connections in support structures using system compliant HALFEN Bolts.

Observe the manufacturer's instructions for installation and application.

Nominal channel dimensions (width × height): 52 mm × 34 mm

Length (mm): .....

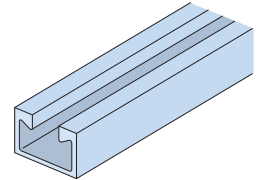

##### **HALFEN FRAMING CHANNEL HM 50/30 - FV - 6070**

HALFEN – Framing channel HM 50/30 hot-rolled galvanized, with CE marking in accordance with ETA 19/0438.

Material: WB Mill finish steel, delivered in 6.07 metre units, cut to specified length and installed. For adjustable connections in support structures using system compliant HALFEN Bolts.

Observe the manufacturer's instructions for installation and application.

Nominal channel dimensions (width × height): 50 mm × 30 mm

Length (mm): .....

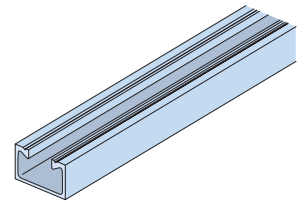

##### **HALFEN FRAMING CHANNEL HZM 53/34 - A4 - 6070**

HALFEN – Framing channel HZM 53/34 channel, hot-rolled and serrated, A4, with CE marking in accordance with DIN EN 1090.

Material: (A4) stainless steel, 1.4571/1.4404, delivered in approx. 6.07 metre units, cut to specified length and installed. For adjustable connections in support structures using system compliant serrated HALFEN Bolts.

Observe the manufacturer's instructions for installation and application.

Nominal channel dimensions (width × height): 53 mm × 34 mm

Length (mm): .....

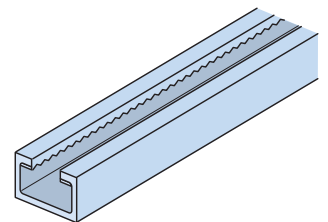

##### **HALFEN Cantilever KON 36/2, hot-dip galvanized**

HALFEN – Cantilever, KON 36/2, hot-dip galvanized (FV), with CE marking in accordance with DIN EN 1090, For adjustable connection in support structures using system compliant HALFEN Bolts.

Required cantilever length according to on-site specifications.

Length (mm): .....

Deliver and install.

Observe the manufacturer's instructions for installation and application.

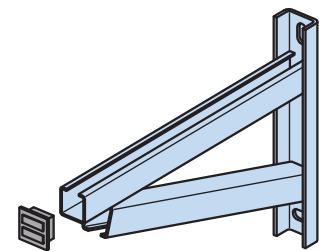

Further tender specifications at: [www.halfen.com/Service/Tender texts](http://www.halfen.com/Service/Tender%20texts)

## HALFEN INDUSTRIAL TECHNOLOGY

### The Innovation in Pipeline Construction

The multi-functional system for any project

#### POWERCLICK SYSTEM 63



Suitable for pipes with nominal diameters up to DN 150 mm or with separate verification up to 400 mm  
→ Catalogue PC 63

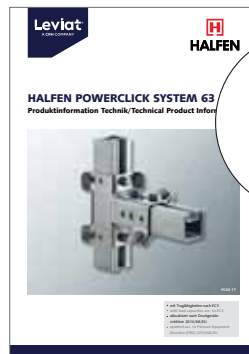

TESTED  
ACC. TO EN 13480  
(TYPE TESTING)  
BY TÜV  
POWERCLICK  
SYSTEM 63

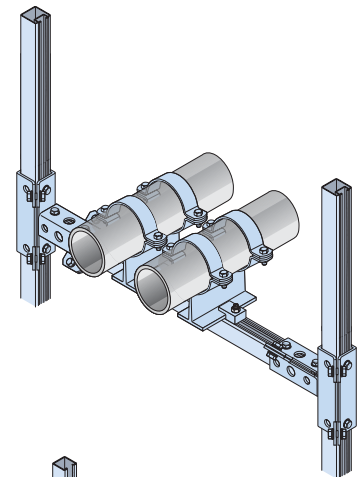

#### POWERCLICK SYSTEM 41



Suitable for pipes with nominal diameters up to DN 80 mm or with separate verification for up to DN 150 mm with short spans sizes  
→ Catalogue PC 41

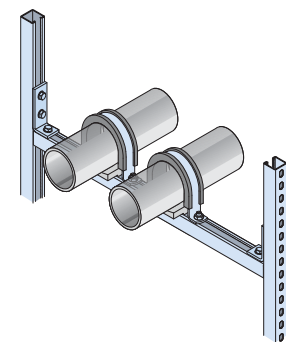

#### POWERCLICK SYSTEM 22



Suitable for pipes with nominal diameters up to DN 25 mm  
→ Catalogue PC 41

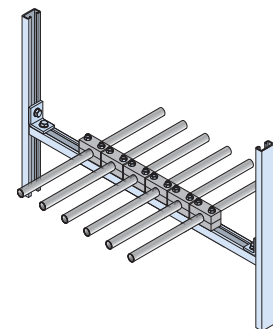
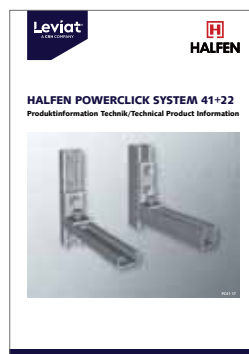

#### POWERCLICK ACCESSORIES

Cantilever brackets, pipe clamps, sliding supports  
→ Catalogue PC Z



Product information on the internet.  
Catalogues and tender texts available at:  
[www.halfen.com/Products/Powerclick](http://www.halfen.com/Products/Powerclick).  
Or scan the code, select the required document and download the PDF.



## HALFEN INDUSTRIAL TECHNOLOGY

### Index

Product/keyword	Page
Accessories	54-59
Adjustment coupler HJV	59
Bending load bearing capacities - framing channels	62-67
Bending moments HALFEN Bolts	71
Bolt length - calculation of	10
Bolts	9, 56-57
Cantilevers KON	61
Cap for channel ends HPE	55
CE marking	6
Channel cover PA	55
Channel end cap	55
Compression elements	72-73
Coupler sleeves VBM, SKM	59
Coupler sleeves with right-hand left-hand thread	59
Dynamic loads	76
European standards	6
Flexural buckling - framing channels	72-73
Framing channels - type overview	8, 14-15
-non slotted HM, HZM hot-rolled	62-63
-non slotted HM, HZM cold-rolled	64-65
-with slot hole HL, HZL	66-67
Geometry - slot holes and spacings	66
HALFEN Bolts type HS, HZS, HSR	9
HALFEN Cast-in channels for installation in concrete	7
HALFEN Framing channels - product overview	14-15
Hexagonal Bolts HSK	59
Hexagonal coupler sleeves	59
Hexagonal nuts MU	58

Product/keyword	Page
Load capacities - framing channels	62-65
Locking plates	10
Locking washers SIC	58
Materials	12-13
Nuts MU	58
Ordering examples	10
Point-load capacity	68-70
Powerclick	41-83
Preloading force	77
Product range - Framing channels	14-15
Product range - HALFEN Bolts	56-57
Ring nuts RM	59
Serrated cast in channels	7
Square washer VUS	58
Stainless steel profiles - overview	14-15
Stand-off installation	71
Tender texts	82
Threaded rods GWS	59
Toothed channels = serrated channels	8, 14-15
Turnbuckles with right- and left-hand sleeves	59
Verification method - explanation	6
Washers	58









**Leviat<sup>®</sup>**  
A CRH COMPANY

Innovative engineered products and construction solutions that allow the industry to build safer, stronger and faster.





## Worldwide contacts for Leviat:

### Australia

**Leviat**  
98 Kurrajong Avenue,  
Mount Druitt Sydney, NSW 2770  
Tel: +61 - 2 8808 3100  
Email: info.au@leviat.com

### Austria

**Leviat**  
Leonard-Bernstein-Str. 10  
Saturn Tower, 1220 Wien  
Tel: +43 - 1 - 259 6770  
Email: info.at@leviat.com

### Belgium

**Leviat**  
Borkelstraat 131  
2900 Schoten  
Tel: +32 - 3 - 658 07 20  
Email: info.be@leviat.com

### China

**Leviat**  
Room 601 Tower D, Vantone Centre  
No. A6 Chao Yang Men Wai Street  
Chaoyang District  
Beijing · P.R. China 100020  
Tel: +86 - 10 5907 3200  
Email: info.cn@leviat.com

### Czech Republic

**Leviat**  
Business Center Šafránková  
Šafránková 1238/1  
155 00 Praha 5  
Tel: +420 - 311 - 690 060  
Email: info.cz@leviat.com

### Finland

**Leviat**  
Vädursgatan 5  
412 50 Göteborg / Sweden  
Tel: +358 (0)10 6338781  
Email: info.fi@leviat.com

### France

**Leviat**  
18, rue Goubet  
75019 Paris  
Tel: +33 - 1 - 44 52 31 00  
Email: info.fr@leviat.com

### Germany

**Leviat**  
Liebigstrasse 14  
40764 Langenfeld  
Tel: +49 - 2173 - 970 - 0  
Email: info.de@leviat.com

### India

**Leviat**  
309, 3rd Floor, Orion Business Park  
Ghodbunder Road, Kapurbawdi,  
Thane West, Thane,  
Maharashtra 400607  
Tel: +91 - 22 2589 2032  
Email: info.in@leviat.com

### Italy

**Leviat**  
Via F.lli Bronzetti 28  
24124 Bergamo  
Tel: +39 - 035 - 0760711  
Email: info.it@leviat.com

### Malaysia

**Leviat**  
28 Jalan Anggerik Mokara 31/59  
Kota Kemuning, 40460 Shah Alam  
Selangor  
Tel: +603 - 5122 4182  
Email: info.my@leviat.com

### Netherlands

**Leviat**  
Oostermaat 3  
7623 CS Borne  
Tel: +31 - 74 - 267 14 49  
Email: info.nl@leviat.com

### New Zealand

**Leviat**  
2/19 Nuttall Drive, Hillsborough,  
Christchurch 8022  
Tel: +64 - 3 376 5205  
Email: info.nz@leviat.com

### Norway

**Leviat**  
Vestre Svanholmen 5  
4313 Sandnes  
Tel: +47 - 51 82 34 00  
Email: info.no@leviat.com

### Philippines

**Leviat**  
2933 Regus, Joy Nostalg,  
ADB Avenue  
Ortigas Center  
Pasig City  
Tel: +63 - 2 7957 6381  
Email: info.ph@leviat.com

### Poland

**Leviat**  
Ul. Obornicka 287  
60-691 Poznań  
Tel: +48 - 61 - 622 14 14  
Email: info.pl@leviat.com

### Singapore

**Leviat**  
14 Benoi Crescent  
Singapore 629977  
Tel: +65 - 6266 6802  
Email: info.sg@leviat.com

### Spain

**Leviat**  
Polígono Industrial Santa Ana  
c/ Ignacio Zuloaga, 20  
28522 Rivas-Vaciamadrid  
Tel: +34 - 91 632 18 40  
Email: info.es@leviat.com

### Sweden

**Leviat**  
Vädursgatan 5  
412 50 Göteborg  
Tel: +46 - 31 - 98 58 00  
Email: info.se@leviat.com

### Switzerland

**Leviat**  
Hertistrasse 25  
8304 Wallisellen  
Tel: +41 - 44 - 849 78 78  
Email: info.ch@leviat.com

### United Kingdom

**Leviat**  
A1/A2 Portland Close  
Houghton Regis LU5 5AW  
Tel: +44 - 1582 - 470 300  
Email: info.uk@leviat.com

### USA / Canada

**Leviat**  
6467 S Falkenburg Rd.  
Riverview, FL 33578  
Tel: (800) 423-9140  
Email: info.us@leviat.us

### For countries not listed

Email: info@leviat.com

**Leviat.com**

For information on certified management systems and standards see [www.ancon.co.uk](http://www.ancon.co.uk) | [www.aschwanden.com](http://www.aschwanden.com) | [www.halfen.com](http://www.halfen.com)

#### Notes regarding this catalogue

© Protected by copyright. The construction applications and details provided in this publication are indicative only. In every case, project working details should be entrusted to appropriately qualified and experienced persons. Whilst every care has been exercised in the preparation of this publication to ensure that any advice, recommendations or information is accurate, no liability or responsibility of any kind is accepted by Leviat for inaccuracies or printing errors. Technical and design changes are reserved. With a policy of continuous product development, Leviat reserves the right to modify product design and specification at any time.



**Imagine. Model. Make.**

**Leviat.com**